

**Draft Woollahra Development Control Plan 2015
(Amendment No 2)**

23 November 2016

CONTENTS

PART 1	PRELIMINARY	1
1.1	Background	1
1.2	Name of plan	1
1.3	Objectives of the plan	1
1.4	Land to which this plan applies	2
1.5	Relationship of this plan to the Act, Regulation and other plans or environmental planning instruments	2
1.6	Approval and commencement of this plan	2
PART 2	AMENDMENTS TO WOOLLAHRA DEVELOPMENT CONTROL PLAN 2015	3
2.1	Chapter B3 General Development Controls	3
2.2	Clause A1.4	3
2.3	Clause A1.1.9 Savings and transitional provisions relating to development applications	3
ANNEXURE 1 AMENDED CHAPTER B3 GENERAL CONTROLS		

Part 1 Preliminary

1.1 Background

The Draft Woollahra Development Control Plan (Amendment No 2) (the plan) has been prepared in response to Council's resolution of 14 November 2016:

- A. That the overview of the Woollahra DCP 2015 Working Party meetings held on 2 March 2016, 21 April 2016 and 4 August 2016 is received and noted.
- B. That Council resolve to prepare and exhibit a draft development control plan to amend Chapter B3 General Development controls of the Woollahra Development Control Plan 2015.
- C. That the draft chapter as contained in Annexure 8 of the report to the Urban Planning Committee of 31 October 2016 be used for the purpose of preparing the draft DCP.
- D. That staff report on the submissions received during the public exhibition to a future meeting of the Urban Planning Committee.

The plan amends Woollahra Development Control Plan 2015 (Woollahra DCP 2015) to include:

- Amended objectives to encourage and facilitate design excellence
- Simplified front, side and rear building setback controls
- Clarification of possible variations to the inclined plane and wall height controls
- Replacement of the "floorplate" control with a "footprint" control
- Amended excavation controls to clarify inclusions to volumetric calculations, and clarify basement wall side setbacks
- Minor amendments to acoustic privacy, on-site parking, landscaping, fence and battle-axe lot controls

1.2 Name of plan

This plan is the Draft Woollahra Development Control Plan 2015 (Amendment No 2).

1.3 Objectives of the plan

The objectives of the plan are to update existing controls and create a control set which:

- Is easy for applicants to understand
- Is expressed in simple language
- Allows a site's development yield to be easily calculated
- Provides an effective assessment framework for staff
- Allows development compliance to be easily determined

1.4 Land to which this plan applies

This plan applies to land identified on Map 1 of section B3.1.1 of Woollahra DCP 2015 (as shown below). The land comprises of the 10 Residential Precincts and 11 Neighbourhood Heritage Conservation Areas identify in the Woollahra DCP 2015.

MAP 1 The land where this chapter applies

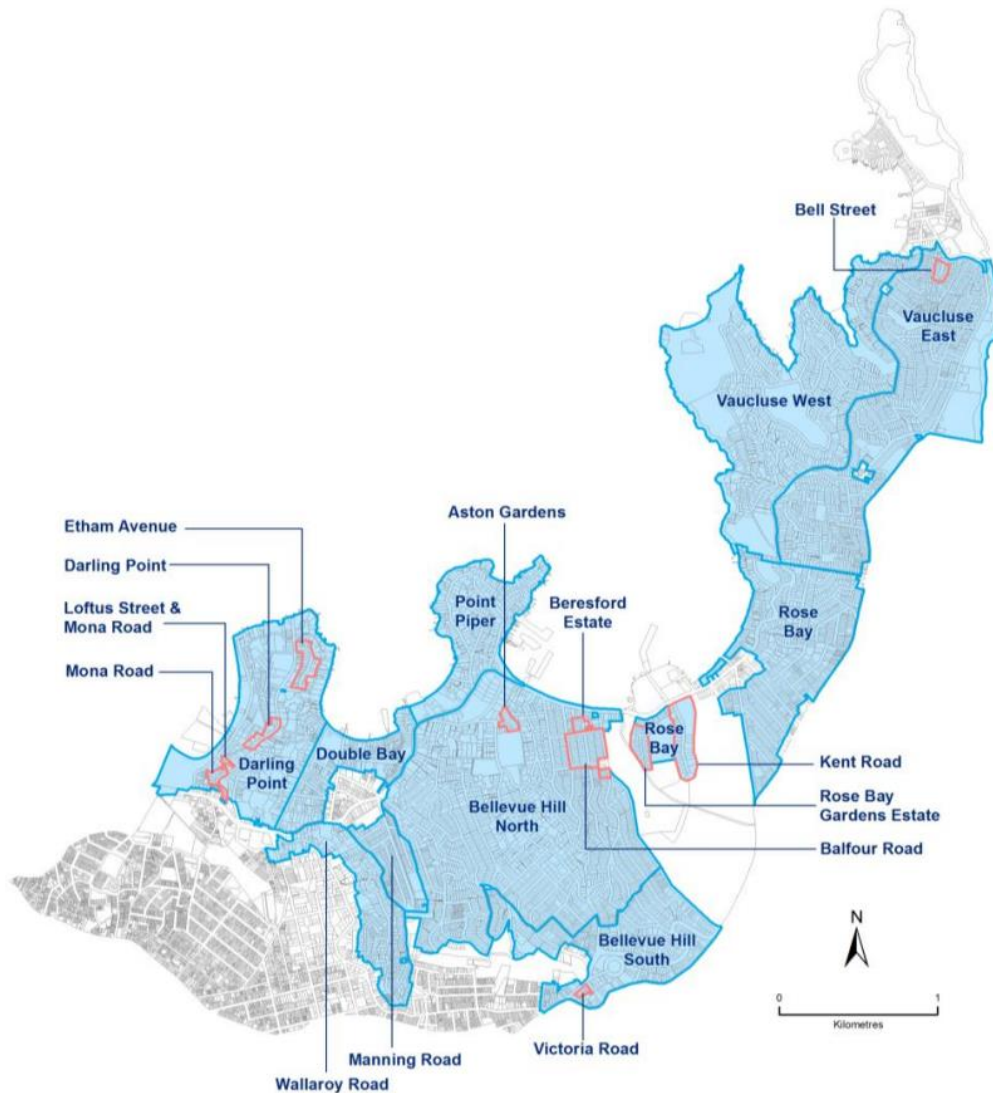

1.5 Relationship of this plan to the Act, Regulation and other plans or environmental planning instruments

This plan has been prepared under section 74C of the *Environmental Planning and Assessment Act 1979* and Part 3 of the *Environmental Planning and Assessment Regulation 2000*.

Woollahra Local Environmental Plan 2014 applies to the land to which this plan applies.

1.6 Approval and commencement of this plan

This plan was approved by Woollahra Council onand came into effect on

Part 2 Amendments to Woollahra Development Control Plan 2015

2.1 Chapter B3 General Development Controls

Delete the chapter and insert instead the chapter attached as **Annexure 1**.

2.2 Clause A1.4

Insert as appropriate in the table:

Amendment	Date of commencement	Description of amendment
No 2	xxx	<p>Amend Chapter B3 General Development Controls by amending and inserting various controls for general development related to:</p> <ul style="list-style-type: none">• Amend design excellence objectives• Simplified front, side and rear building setback controls• Clarify variations to the inclined plane and wall height controls• Replace “floorplate” control with a “footprint” control• Amend excavation volumetric calculations• Clarify basement wall side setback controls• Make minor amendments to acoustic privacy, on-site parking, landscaping, fence and battle-axe lot controls

2.3 Clause A1.1.9 Savings and transitional provisions relating to development applications

Insert the following after the existing paragraphs:

This DCP (as commenced on 23 May 2015) continues to apply to development applications, applications to modify consents under section 96 of the EP&A Act and applications for review of determinations under section 82A of the EP&A Act that were made prior to but not determined before the commencement of Amendment No 2 to this DCP.

Annexure 1

DRAFT FOR EXHIBITION - 23 NOVEMBER 2016

Chapter B3 General Development Controls

Part B ► General Residential

Chapter B3 ► General Development Controls

Contents

B3.1	INTRODUCTION	1
	B3.1.1 Land where this chapter applies	1
	B3.1.2 Development to which this chapter applies	2
	B3.1.3 Design Excellence	3
	B3.1.4 Relationship to other parts of the DCP	3
	B3.1.5 How to use this chapter	3
B3.2	BUILDING ENVELOPE	5
	B3.2.1 Where the building envelope controls apply	5
	B3.2.2 Front setback	7
	B3.2.3 Side setbacks	9
	B3.2.4 Rear setback	12
	B3.2.5 Wall height and inclined plane	14
B3.3	FOOTPRINT	16
B3.4	EXCAVATION	19
B3.5	BUILT FORM AND CONTEXT	23
	B3.5.1 Streetscape character	23
	B3.5.2 Overshadowing	24
	B3.5.3 Public and private views	25
	B3.5.4 Acoustic and visual privacy	28
B3.6	ON-SITE PARKING	33
B3.7	EXTERNAL AREAS	37
	B3.7.1 Landscaped areas and private open space	37
	B3.7.2 Fences	42
	B3.7.3 Site facilities	45
	B3.7.4 Ancillary development - swimming pools, tennis courts and outbuildings	48
B3.8	ADDITIONAL CONTROLS FOR DEVELOPMENT OTHER THAN DWELLING HOUSES	51
	B3.8.1 Minimum lot width	51
	B3.8.2 Secondary dwellings	52
	B3.8.3 Semi-detached dwellings	53
	B3.8.4 Dual occupancy	55
	B3.8.5 Attached dwellings	56
	B3.8.6 Residential flat buildings and multi dwelling housing	57
	B3.8.7 Inter-War flat buildings	59
	B3.8.8 Post-1950s residential towers	68
	B3.8.9 Non-residential development	69
B3.9	ADDITIONAL CONTROLS FOR DEVELOPMENT ON A BATTLE-AXE LOT	71
B3.10	ADDITIONAL CONTROLS FOR DEVELOPMENT IN SENSITIVE LOCATIONS	74
	B3.10.1 Development on land adjoining public open space	74
	B3.10.2 Harbour foreshore development	76

DRAFT

B3.1 Introduction

This is Chapter B3 of the Woollahra Development Control Plan 2015 (DCP), Part B General Residential. The controls in this chapter must be read in conjunction with the controls in Chapter B1 Residential Precincts and Chapter D2 Neighbourhood Heritage Conservation Areas (HCAs).

The Woollahra Local Environmental Plan 2014 (Woollahra LEP 2014) includes building height controls, floor space ratios in the R3 Medium Density Residential Zone and the minimum lot size required for subdividing or developing land.

The controls in this chapter guide the scale and bulk of development so that is compatible with site conditions and the desired future character of the location where the development is proposed.

B3.1.1 Land where this chapter applies

This chapter applies to land identified on Map 1 below.

MAP 1 The land where this chapter applies

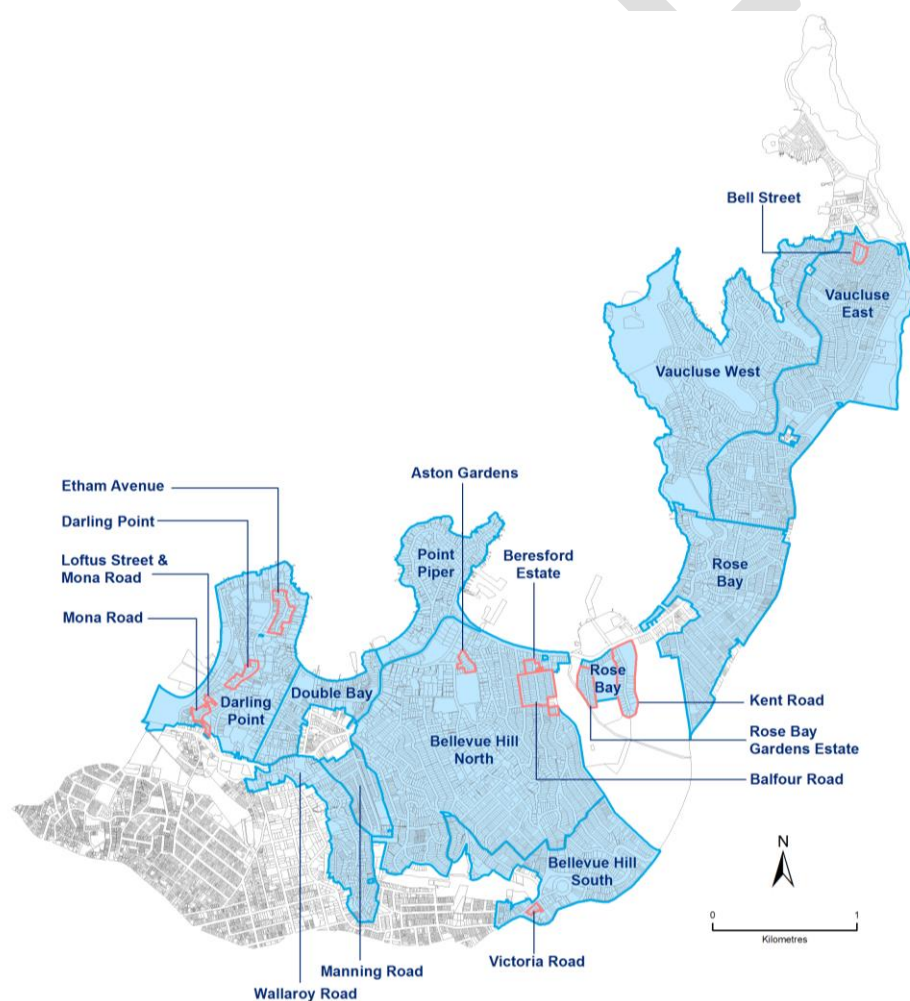

The area comprises:

10 Residential Precincts

- ▶ Darling Point
- ▶ Double Bay
- ▶ Wallaroy
- ▶ Manning Road
- ▶ Point Piper
- ▶ Bellevue Hill South
- ▶ Bellevue Hill North
- ▶ Rose Bay
- ▶ Vaucluse West
- ▶ Vaucluse East

11 Neighbourhood HCAs

- ▶ Etham Avenue, Darling Point
- ▶ Darling Point Road, Darling Point
- ▶ Mona Road, Darling Point
- ▶ Loftus Road and Mona Road, Darling Point
- ▶ Aston Gardens, Bellevue Hill
- ▶ Victoria Road, Bellevue Hill
- ▶ Balfour Road, Rose Bay
- ▶ Beresford Estate, Rose Bay
- ▶ Rose Bay Gardens Estate, Rose Bay
- ▶ Kent Road, Rose Bay
- ▶ Bell Street, Vaucluse

B3.1.2 Development to which this chapter applies

This chapter applies to development that requires development consent. This includes new development and additions and alterations.

Generally this will be residential development, but may include other permitted uses such as child care centres, community facilities, educational establishments, neighbourhood shops and places of public worship, and other uses permitted in Woollahra LEP 2014.

This area is predominantly zoned R2 Low Density Residential and R3 Medium Density Residential, but also includes land zoned SP2 Infrastructure, RE1 Public Recreation, RE2 Private Recreation, E1 National Parks and Nature Reserves and E2 Environmental Conservation.

Note: Those provisions in Woollahra DCP 2015 that specify requirements, standards or controls that relate to certain matters which are listed in clause 6A of the State Environmental Planning Policy No 65 - Design Quality of Residential Apartment Development (SEPP 65) have no effect in the assessment and determination of a development application for development to which SEPP 65 applies.

Residential apartment development is defined in clause 4 of SEPP 65. It comprises residential flat buildings, shop top housing and mixed use development with a residential accommodation component. The building must be at least three or more storeys (excluding levels below existing ground level or levels that are less than 1.2m above existing ground level that provide car parking). The building must contain at least four or more dwellings.

All other provisions of Woollahra DCP 2015 apply to the assessment and determination of a DA for development to which SEPP 65 applies.

B3.1.3 Design Excellence

Woollahra Council has a strong commitment to design excellence. Design excellence may be achieved by development that meets the following criteria, as well as all other relevant objectives and controls in this chapter.

1. Development contributes positively to the desired future character of the relevant residential precinct described in section B1 of this DCP.
2. Development respects the natural, built and cultural significance of the site and its location.
3. Development conserves and protects established and significant trees, plantings and deep soil landscaping and, where possible, enhances plantings and deep soil landscaping.
4. Development responds to the topography and minimises excavation.
5. Development provides high levels of amenity for both private and public land.
6. Development incorporates the principles of ecologically sustainable development, such as:
 - minimising energy consumption,
 - reducing potable water use,
 - using energy and water efficient appliances,
 - using environmentally friendly products, and
 - enhancing indoor environmental quality.

B3.1.4 Relationship to other parts of the DCP

This chapter is to be read in conjunction with the other parts of the DCP that are relevant to the development proposal, including:

- ▶ Part B: Chapter B1 Residential Precincts OR Chapter B2 Neighbourhood HCAs, depending on the location of the proposed development.
- ▶ Part E: General Controls for All Development - this part contains chapters on Parking and Access, Stormwater and Flood Risk Management, Tree Management, Contaminated Land, Waste Management, Sustainability, Signage and Adaptable Housing.
- ▶ Part F: Land Use Specific Controls - this part contains chapters on Child Care Centres, Educational Establishments, Licensed Premises and Telecommunications.

B3.1.5 How to use this chapter

This chapter establishes controls for the following topics:

- ▶ building envelopes;
- ▶ footprint;
- ▶ excavation;
- ▶ built form and context;

-
- ▶ on-site parking;
 - ▶ external areas;
 - ▶ additional controls for development other than a dwelling house;
 - ▶ additional controls for development on a battle-axe lot; and
 - ▶ additional controls for development in sensitive locations (for example harbour foreshore development and land adjoining public open space).

The controls in this chapter comprise the following elements:

- ▶ **Explanation of the topic:**

This provides background information on why the topic is important, how it is relevant to building design, and how the controls should be applied.

- ▶ **Table of objectives and controls:**

The objectives describe the outcomes that proposed development is required to achieve. Applicants need to demonstrate how their development fulfils the relevant objectives for each topic. The controls represent specific ways in which a development proposal can meet the objectives. The intent of the controls must be interpreted in the context of the topic's objectives.

Development is required to address all the relevant controls. Where there is a disparity between these general controls and the precinct specific controls in Chapters B1 and B2, those specific controls take precedence over the general controls.

B3.2 Building envelope

The building envelope is a three dimensional space within which a building is to be located.

B3.2.1 Where the building envelope controls apply

Development in the R2 Low Density Residential Zone

The building envelope (as shown in Figure 1) is established by applying the following controls:

- ▶ front, side and rear setbacks;
- ▶ maximum wall height of 7.2m;
- ▶ inclined plane of 45° taken from the maximum wall height; and
- ▶ maximum building height set by Woollahra LEP 2014.

The building is to be contained within the building envelope, but is to occupy only a percentage of the building envelope (as determined by the footprint controls in Section B3.3 Footprint). There is an allowance of 450mm for eaves outside the building envelope as long as the protrusion is below the inclined plane (where one applies). However, the eaves are included in the footprint (refer to footprint 11).

Note: Additional controls apply to development on a battle-axe lot (refer Section B3.9).

FIGURE 1 Building envelope

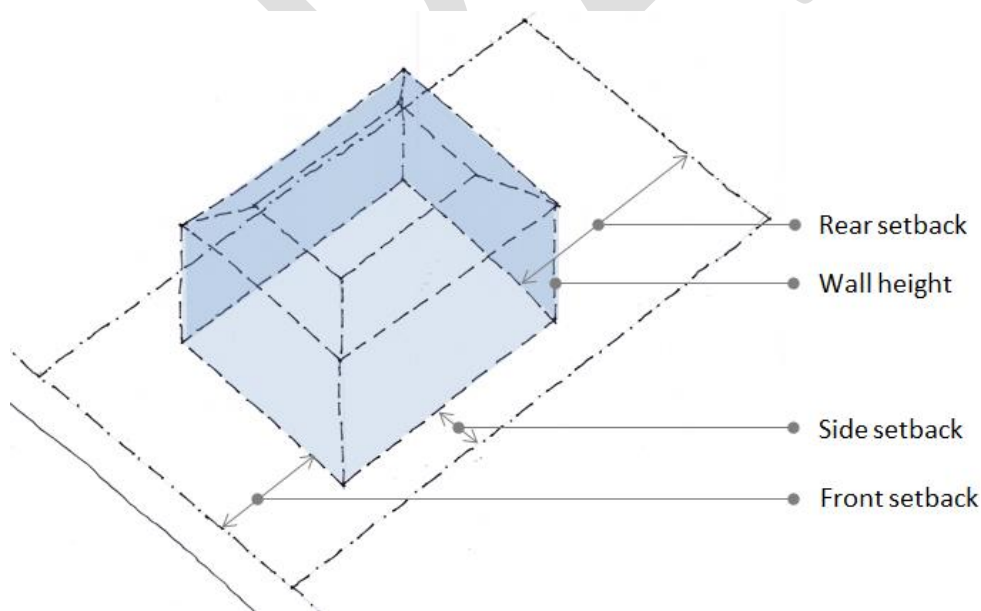

Development for dwelling houses, semi-detached dwellings and dual occupancies in the R3 Medium Density Residential zone

In the R3 Medium Density Residential Zone, an FSR control does not apply to dwelling houses, semi-detached dwellings and dual occupancies in Woollahra LEP 2014 (clause 4.4(2A)). The development potential for these uses is determined by the same building envelope that applies to the development in the R2 Low Density Residential Zone (see above).

All other development in the R3 Medium Density Residential Zone

In the R3 Medium Density Residential Zone, an FSR control applies to all development except dwelling houses, semi-detached dwellings and dual occupancies.

Where an FSR control applies, the building envelope is established by applying the following controls:

- ▶ front, side and rear setbacks;
- ▶ maximum building height set by Woollahra LEP 2014.

The wall height, inclined plane and footprint controls do not apply.

The development, such as a residential flat building, is to be contained within the building envelope. However, the proposed building may only occupy a portion of the building envelope as determined by the maximum FSR control in the LEP.

B3.2.2 Front setback

Front setbacks establish the position of buildings in relation to the street boundary. They create the spatial proportions of the street and can contribute to the streetscape character by providing consistency.

Buildings and plantings on private land form essential parts of the streetscape. Front setbacks should be used to enhance the setting for the building, providing landscaped areas and access to the building.

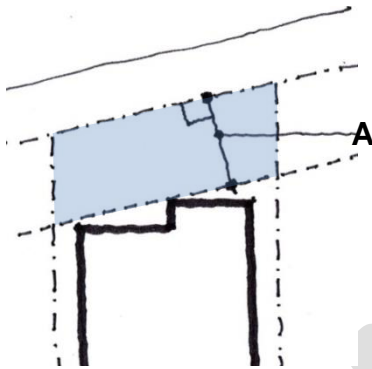

FIGURE 2
Front setback measurement

Example

A = Front setback measured at 90° to the front boundary

B3.2 Building envelope ▶ 3.2.2 Front setback

Objectives	Controls
O1 To reinforce the existing streetscape and character of the location.	C1 The front setback of the building envelope is determined by averaging the three most typical setbacks of the four closest residential buildings that face the same side of the street (refer to Figure 3). Note: The front setback is the horizontal distance between the building envelope and the primary street boundary, measured at 90° from the boundary (refer to Figure 2). Note: On corner lots, the shortest frontage to a street is typically where the front setback applies.
O2 To provide consistent front setbacks in each street.	Note: These controls do not apply to battle-axe lots (refer to Section B3.9).
O3 To provide for landscaped area and deep soil planting forward of the building.	

B3.2 Building envelope ▶ 3.2.2 Front setback

Objectives	Controls
<p>O4 To ensure that buildings are well articulated and positively contribute to the streetscape.</p>	<p>C2 The building has a maximum unarticulated width of 6m to the street frontage.</p>

FIGURE 3

Setbacks of the four closest residential buildings are determined by the distance between the primary street boundary and the outside face of the front building wall, or any protruding balcony deck or the like (excluding garages or carports).

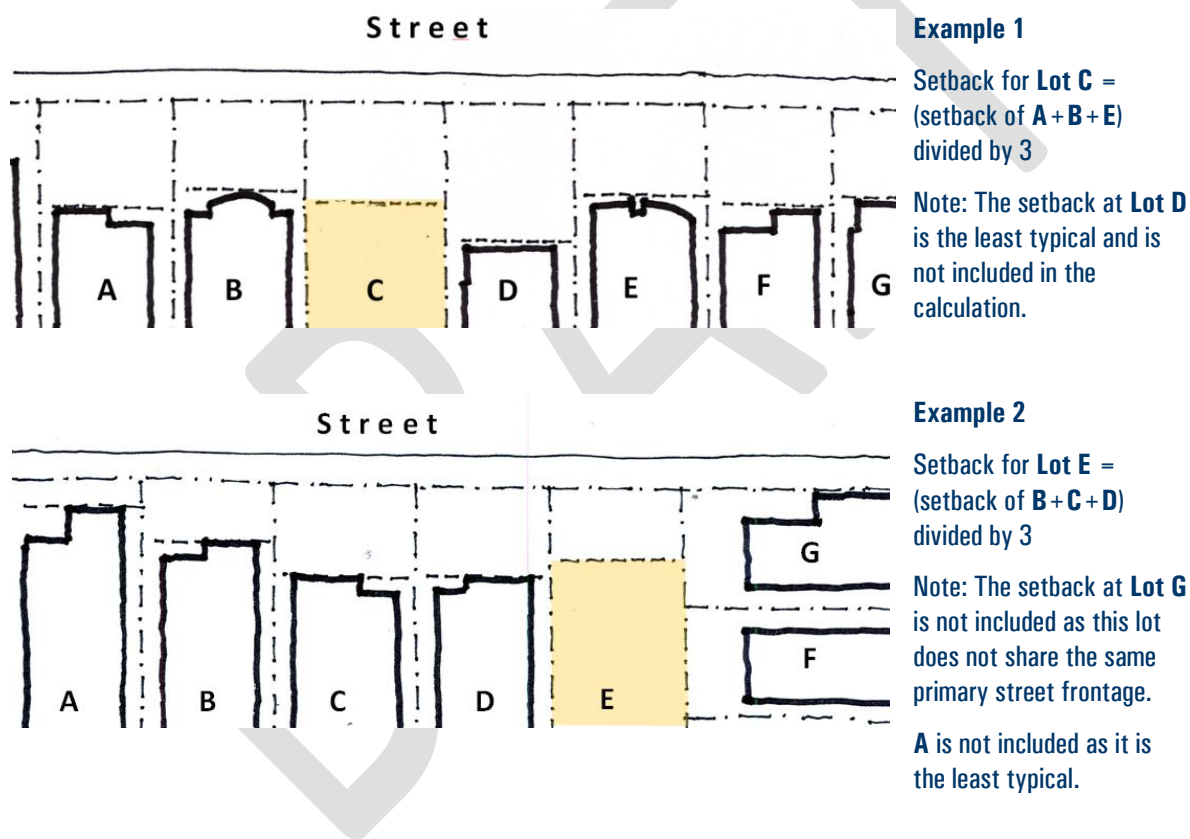

B3.2.3 Side setbacks

The side setback control seeks to ensure that the distance of a building from its side boundaries protects the amenity of both the neighbours and the proposed development.

The minimum side setback requirement varies according to the lot width and building type.

B3.2 Building envelope ▶ 3.2.3 Side setbacks	
Objectives	Controls
O1 To avoid an unreasonable sense of enclosure and to facilitate an appropriate separation between buildings.	C1 The side setback for dwelling houses, semi-detached dwellings and dual occupancies is determined by the table in Figure 5.
O2 To ensure the side elevation of buildings are well articulated.	C2 The minimum side setback for residential flat buildings, attached dwellings and multi-dwelling housing is determined by the table in Figure 6.
O3 To facilitate solar access to habitable windows of adjoining properties.	C3 The minimum side setback for any other land use not addressed in controls C1 to C2 above is determined by the table in Figure 6. Note: The side setback is the horizontal distance between the side property boundary and the building envelope, measured at 90° from the boundary, as shown in Figure 4. Note: For controls C2 and C3 setbacks include any basement piling or similar structured forms
O4 To facilitate views between buildings.	
O5 To provide opportunities for screen planting.	
O6 To allow external access between the front and rear of the site.	
	C4 The building has a maximum unarticulated wall length of 12m to the side elevation. Note: A reduced side setback may be considered where zero or significantly reduced setbacks are characteristic of the immediate streetscape. These streets may be specifically identified in Chapter B1 Residential Precincts or Chapter B2 Neighbourhood HCAs.

B3.2 Building envelope ▶ 3.2.3 Side setbacks	
Objectives	Controls
<p>O7 To recognise built form characteristics of semi-detached dwellings and attached dwellings.</p>	<p>C5 Notwithstanding C1 to C3 above, the following variations apply:</p> <ul style="list-style-type: none"> a) For a semi-detached dwelling—a zero setback applies at the common boundary between the pair of semi-detached dwellings. b) For attached dwellings—a zero setback applies at the common boundary between each dwelling within the development.

FIGURE 4
Side setback measurement, B depends on A

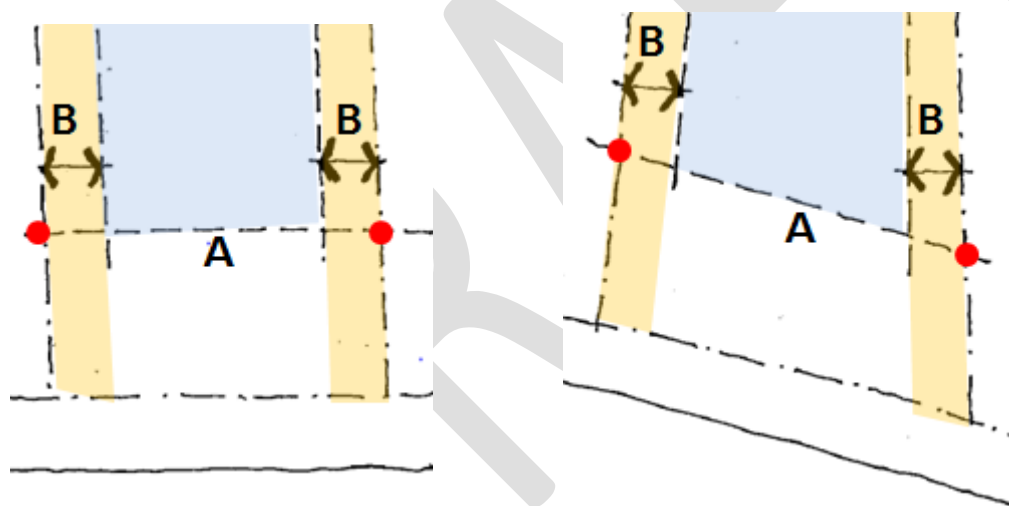

FIGURE 5

Side setback table for dwelling houses, semi-detached dwellings and dual occupancies

A. Site width measured along front setback line in metres	B. Side setback in metres
< 9.0	0.9
9.0 - < 11.0	1.1
11.0 - < 13.0	1.3
13.0 - < 15.0	1.5
15.0 - < 17.0	1.9
17.0 - < 19.0	2.3
19.0 - < 21.0	2.7
21.0 - < 23.0	3.1
23.0 +	3.4

FIGURE 6

Side setback table for Residential flat buildings, multi dwelling housing and attached dwellings, and any other land use not addressed in controls C1 to C2 of Section 3.2.3 Side setbacks

A. Site width measured along front setback line in metres	B. Side setback in metres
<18.0	1.5
18.0 - < 21.0	2.0
21.0 - < 28.0	2.5
28.0 - < 35.0	3.0
35.0 +	3.5

B3.2.4 Rear setback

The rear setback control seeks to ensure that the distance of a building from its rear boundary provides amenity to both the neighbouring sites and the proposed development.

In particular, the rear setback provides useable land for private open space and landscaping, which significantly contributes to amenity for the occupants.

B3.2 Building envelope ▶ 3.2.4 Rear setback	
Objectives	Controls
01 To provide private open space and landscaped areas at the rear of buildings.	C1 The rear setback is 25% of the site depth, being the average of the side boundaries (refer to Figure 7) and is the horizontal distance between the building envelope and the rear property boundary. C2 If 'end to end' amalgamation occurs, the building envelope will be determined as if they were separate lots (refer to Figure 8).
02 To provide acoustic and visual privacy to adjoining and adjacent buildings.	
03 To avoid an unreasonable sense of enclosure.	
04 To provide separation between buildings to facilitate solar access to private open space.	
05 To protect significant vegetation and provide for landscaped area and deep soil planting.	
06 To contribute to a consolidated open space network with adjoining properties to improve natural drainage and support local habitat.	

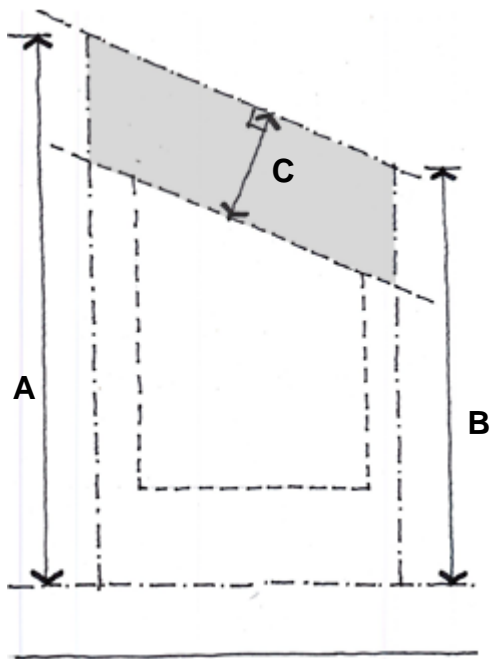

FIGURE 7

Formula for determining rear setback

A = Site depth

B = Rear setback (25% of A)

C = Rear Setback is 25% of the site depth

$$C = ((A+B) / 2) \times 0.25$$

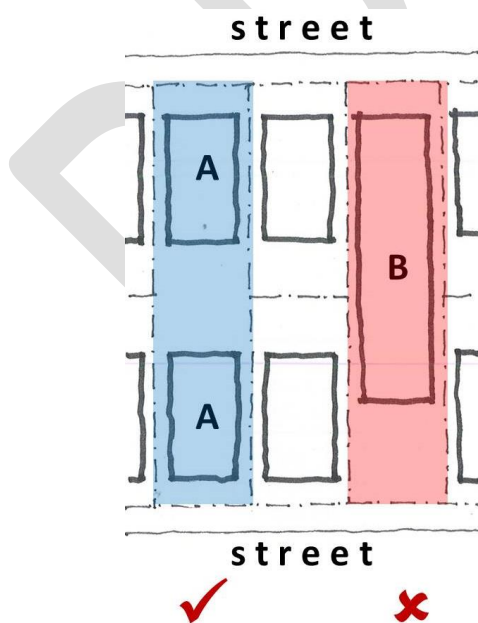

FIGURE 8

Setbacks for end to end amalgamation

When lots are amalgamated end to end, as illustrated in A and B, the rear setback requirement remains as if it were two lots, as illustrated in A. Not as illustrated in B.

B3.2.5 Wall height and inclined plane

The wall height control only applies to:

- ▶ development on land in the R2 Low Density Residential Zone; and
- ▶ dwelling houses, semi-detached dwellings and dual occupancies in the R3 Medium Density Residential zone.

A wall height of 7.2m (accommodating two storeys) and an inclined plane of 45° applies to the front, side and rear elevations. These controls respond to the typical pitched roof house form, but also potentially accommodate three storey flat roof housing forms with a reduced top storey.

B3.2 Building envelope ▶ 3.2.5 Wall height and inclined plane	
Objectives	Controls
O1 To limit the bulk, scale and visual impact of buildings as viewed from the street and from adjoining properties.	C1 On land zoned R2 Low Density Residential and for a dwelling house, semi-detached dwelling or dual occupancy in the R3 Medium Density Residential zone: <ul style="list-style-type: none"> a) the wall height is 7.2m above existing ground level; and b) an inclined plane is taken from a point 7.2m above existing ground level at each of the setbacks (the inclined plane is at 45 degrees from horizontal); and c) roof eaves may protrude a maximum of 450mm into the setback if below the inclined plane. Refer to Figure 9.
O2 To limit overshadowing of adjoining properties across side boundaries.	
O3 To limit overshadowing to south facing rear yards.	
	C2 A variation to the wall height of 7.2m may be considered where the slope of the site within the building envelope is greater than 15 degrees. <p>The variation will only be considered to walls located nearest to the downslope section of the building envelope, i.e. the section with the lowest existing ground level.</p> <p>A request for a variation must demonstrate that the increased wall height is consistent with the objectives of this section of the DCP, consistent with the objectives for development within the zone in which the development is proposed to be carried</p>

B3.2 Building envelope ▶ 3.2.5 Wall height and inclined plane

Objectives

Controls

out, and there are sufficient environmental planning grounds to justify the variation.

Note: The statutory building height control in the Woollahra LEP 2014 applies.

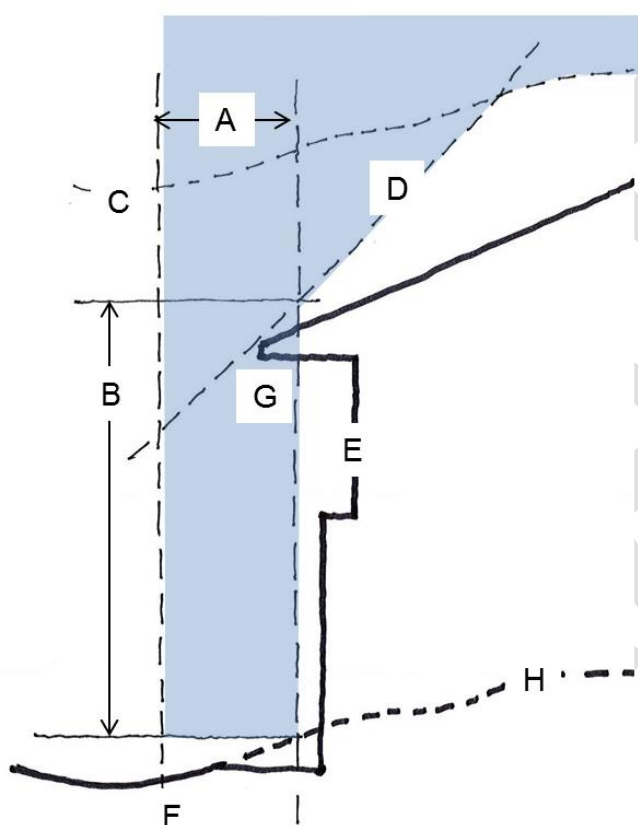

FIGURE 9

Section view of the building envelope with the setbacks and inclined plane

- A** = Side setback
- B** = 7.2m maximum wall height
- C** = Maximum building height: 9.5m above existing ground level
- D** = Inclined plane: 45degrees to horizontal
- E** = Potential built form
- F** = Site boundary
- G** = Roof eaves may protrude a maximum of 450mm into the setback if below the inclined plane
- H** = Existing ground level

B3.3 Footprint

The footprint control only applies to:

- ▶ development on land in the R2 Low Density Residential Zone; and
- ▶ dwelling houses, semi-detached dwellings and dual occupancies in the R3 Medium Density Residential zone.

Note: The footprint control does not apply to land or development types where an FSR applies, such as residential flat buildings, multi dwelling housing, or attached dwellings on land zoned R3 Medium Density Residential.

Measuring footprint

Footprint is measured to include all the site area covered by buildings; where the building is 1.2m or more above existing ground level (refer figures 10 and 11),

but excludes:

- ▶ uncovered external areas, such as terraces and decks that are less than 1.2m above the existing ground level;
- ▶ garaging outside the building envelope where permitted;
- ▶ swimming pools less than 1.2m above existing ground level; and
- ▶ outbuildings.

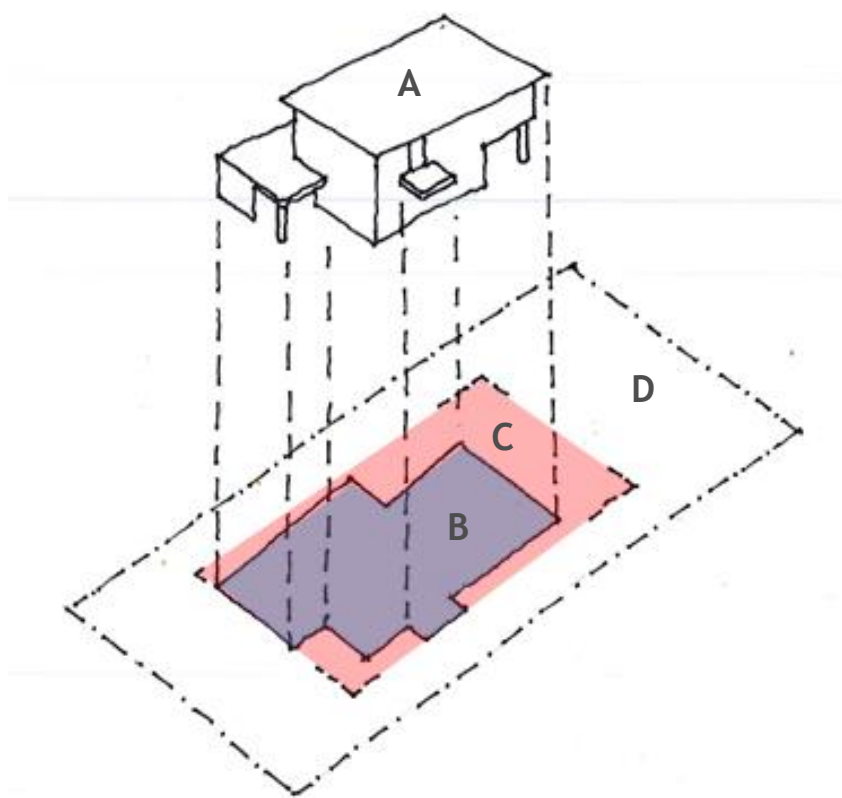

FIGURE 10 Measuring footprint

A = Building

B = Footprint

C = Envelope

D = Site

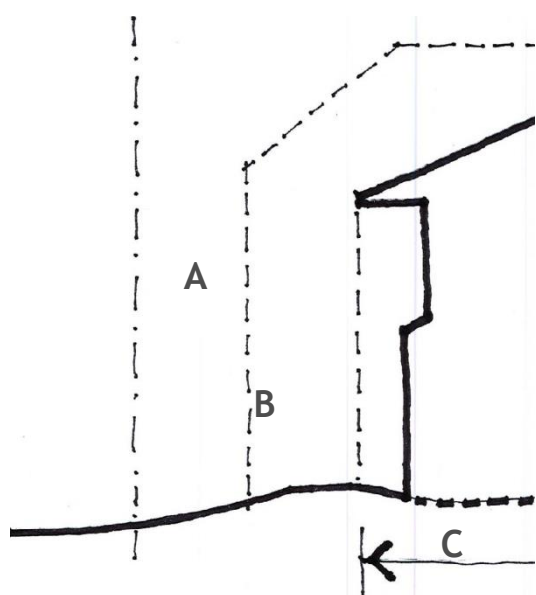

FIGURE 11
Section view of the building showing the footprint
A = Setback
B = Building envelope
C = Footprint

B3.3 Footprint	
Objectives	Controls
<p>O1 To ensure buildings are consistent with the desired future character of the area.</p> <p>O2 To ensure the size and location of buildings allow for the sharing of views and minimise impact on the privacy and sunlight access to neighbouring properties.</p>	<p>C1 The total footprint for development does not exceed the percentage of the site area determined by the footprint table (refer to Figure 12).</p> <p>C2 The footprint is wholly contained within the building envelope (refer to C6 for exceptions).</p> <p>C3 The footprint is positioned to:</p> <ul style="list-style-type: none"> a) respond to the predominant character of the immediate streetscape; b) retain public views; and c) provide for view sharing of private views. <p>C4 The built form complies with solar access and privacy controls in Section 3.5.2 Overshadowing and Section 3.5.4 Acoustic and visual privacy.</p>
<p>O3 To encourage the design and location of car parking within the building envelope.</p>	<p>C5 Where a car parking structure (garage or carport) is wholly or partly provided within the building envelope and the top of the garaging is more than 1.3m above the existing ground level, half the area of the car parking</p>

B3.3 Footprint	
Objectives	Controls
	structure within the building envelope (up to 20m ²) is added to the permitted total footprint”.
O4 To allow development to respond to the topography and context.	<p>C6 Notwithstanding C2, the following buildings are permitted outside the building envelope:</p> <ul style="list-style-type: none"> a) an outbuilding (refer B3.7.4) b) parking structures that comply with B3.6 On-site Parking requirements where; <p>These buildings are only permitted when:</p> <ul style="list-style-type: none"> c) minimum deep soil landscaped area and private open space requirements are met, as set out in Section 3.7.1 Landscaped areas and private open space; and d) solar access and privacy requirements within the site, and to the adjoining properties, are met as set out in Section 3.5.2 Overshadowing and Section 3.5.4 Acoustic and visual privacy.

Figure 12 Footprint table

Site area (square metres)	Percentage of site areas permitted as footprint (%)	
	All precincts (other than Point Piper)	Point Piper
< 200	55	55
200 - < 250	47	48
250 - < 300	41	44
300 - < 350	37	41
350 - < 400	33.5	38
400 - < 450	31	36.5
450 - < 500	30.5	35.5
500 +	30	35

B3.4 Excavation

Excavation is an accepted part of development in the Woollahra Municipality where the topography varies. Excavation allows buildings on the sloping sites to be designed to step down and sit into the hillside, and it also enables cars and storage to be accommodated on site in an unobtrusive manner.

However, there are significant environmental impacts associated with extensive excavation, as well as external impacts, such as amenity impacts to adjoining properties during the excavation process.

Council has determined that the volume excavated from a given site should be limited to that which might reasonably be required for car parking and domestic storage requirements, and to allow the building to respond to the site topography in an appropriate manner.

B3.4 Excavation	
Objectives	Controls
O1 To allow buildings to be designed and sited to relate to the topography.	C1 For a dwelling house, dual occupancy or semi-detached dwelling (including attached and detached garaging)—the maximum volume of excavation permitted is no greater than the volume shown in Figure 13.
O2 To minimise excavation.	
O3 To ensure the cumulative impacts of excavation do not adversely impact land stabilisation, ground water flows and vegetation.	
	C2 For a residential flat building, multi dwelling housing, or attached dwelling development (including attached and detached garaging)—the maximum volume of excavation permitted is no greater than the volume shown in Figure 14.
	C3 For any other use (including attached and detached garaging) not addressed in C1 and C2 above—the maximum volume of excavation permitted is no greater than the volume shown in Figure 14.
	C4 A variation to the volume shown in Figures 14 and 15 will be considered, however the maximum volume of excavation permitted will only be the amount needed to accommodate: <ul style="list-style-type: none"> a) car parking to comply with the maximum rates in Part E1 of this DCP and any reasonable access thereto, if the maximum car parking rates are required by the Council; and b) storage at a rate of 20m³ (cubic metres) per dwelling if for a dwelling house, dual occupancy, semi-detached

B3.4 Excavation	
Objectives	Controls
	<p>dwelling or attached housing; or</p> <p>c) storage at a rate of 8m³ (cubic metres) per dwelling if for a residential flat building or multi dwelling housing development.</p> <p>C5 The volume controls in C1 and C2 above do not apply to backyard swimming pools and tennis courts located outside the building envelope. (Note: Separate controls apply which limit excavation, refer to Section 3.7.4 Ancillary development - swimming pools, tennis courts and outbuildings).</p>
<p>O4 To minimise structural risks to adjoining structures.</p> <p>O5 To minimise noise, vibration, dust and other amenity impacts to adjoining and adjacent properties.</p>	<p>C6 Basement walls are no closer to the boundary than permitted by the setback controls (refer to Figure 15).</p> <p>C7 Notwithstanding C6, basement walls for residential flat buildings, multi dwellings housing and attached dwellings are no closer to the boundary than 1.5m (see Figure 16).</p> <p>C8 Excavation in relation to an existing attached dwelling, semi-detached dwelling, or attached dual occupancy is not to occur under:</p> <ul style="list-style-type: none"> a) common party walls; b) footings to common party wall; c) freestanding boundary walls; d) footings to freestanding boundary walls. <p>C9 Excavation below 2m and/or within 1.5m of the boundary is accompanied by a geotechnical and hydrogeological report and a structural report demonstrating that the works will not have any adverse effect on neighbouring structures.</p> <p>Note: Council may identify other circumstances where these reports are required. All reports must be prepared in accordance with Council’s guidelines. Council may also require the preparation</p>

B3.4 Excavation	
Objectives	Controls
	and submission of a pre-commencement dilapidation report for properties neighbouring the development.

FIGURE 13
 Maximum volume of excavation for the site of:
 - a dwelling house
 - dual occupancy development
 - a semi-detached dwelling

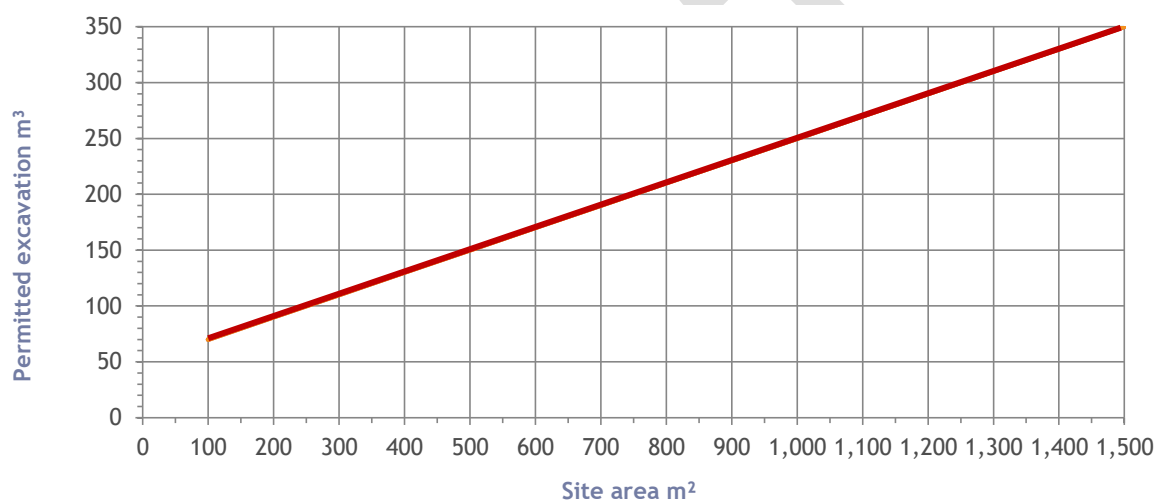
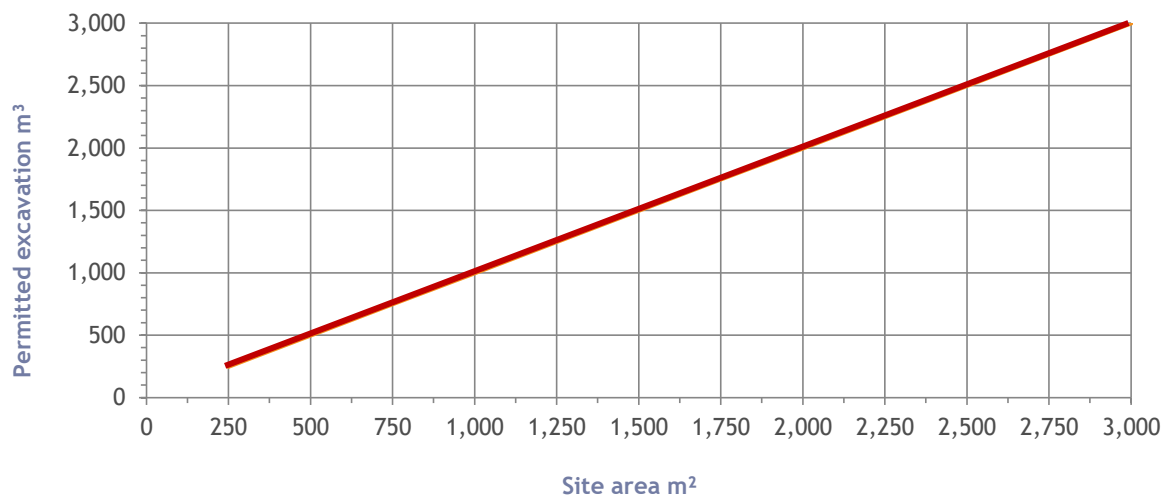

FIGURE 14
 Maximum volume of excavation for the site of:
 - a residential flat building
 - multi dwelling housing
 - attached dwellings
 - any other land use not addressed in controls C1 to C2 of Section B3.4 Excavation



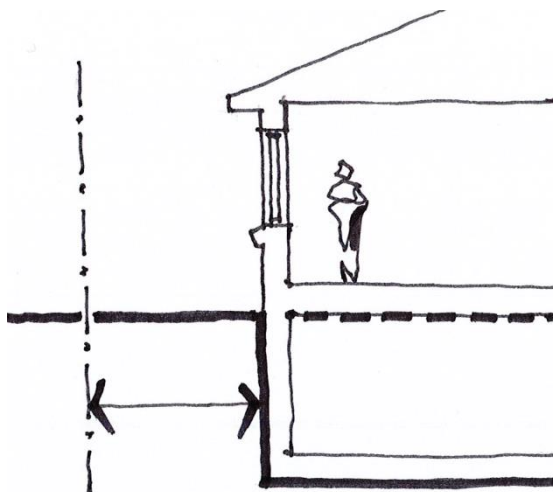

FIGURE 15

For a dwelling house, dual occupancy development and semi-detached dwellings basement walls can be no closer to the boundary than the required setback (refer to Figure 5).

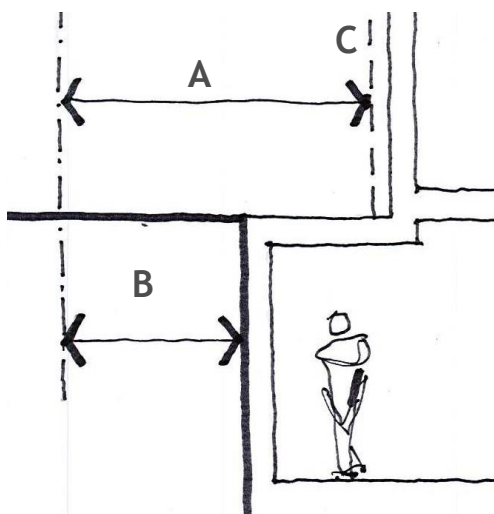

FIGURE 16

For a residential flat building, multi dwelling housing, attached dwellings and any other land use not addressed in controls C1 to C2 of Section B3.4 Excavation, basement walls can be no closer to the boundary than 1.5m.

A- Refer Figure 6

B- Minimum setback 1.5m

C- Building envelope

B3.5 Built form and context

B3.5.1 Streetscape character

A quality streetscape provides good public amenity and contributes to the character and identity of the locality. As character can vary from street to street, it is important that development recognises predominant streetscape qualities, such as building form to ensure a cohesive streetscape character.

B3.5 Built form and context ▶ 3.5.1 Streetscape character	
Objectives	Controls
<p>O1 To ensure that the built form is compatible with the streetscape and the desired future character of the area.</p> <p>O2 To ensure that development is of high visual quality and enhances the street.</p> <p>O3 To maintain the evolution of residential building styles through the introduction of well-designed contemporary buildings.</p>	<p>C1 The building is consistent with the desired future character of the area set out in the precinct controls in Parts B1 and B2 of this DCP.</p> <p>Note: Chapters B1 and B2 in this part of the DCP define the desired future character for each precinct or HCA, and identify special streetscape character, heritage and key elements within each precinct.</p> <p>C2 Development retains existing mature or significant vegetation.</p> <p>C3 Development steps down sloping sites and follows the topography of the land.</p> <p>C4 External building materials and colours do not detract from the streetscape. Bright or obtrusive colour schemes are avoided.</p>
<p>O4 To ensure that roof forms are consistent with the existing predominant roof forms in the street and minimise impacts to neighbouring properties.</p>	<p>C5 In heritage conservation areas or where the existing the immediate streetscape is predominantly characterised by pitched roof forms, new development incorporates pitched roof forms.</p> <p>C6 Roof materials are non-reflective and do not cause excessive glare to adjacent properties.</p>
<p>O5 To ensure buildings improve the safety of the public domain.</p>	<p>C7 The building addresses the street and provides opportunities for casual surveillance. At least one habitable room window overlooks the street.</p>

B3.5.2 Overshadowing

Building bulk should be distributed to minimise overshadowing to neighbouring properties.

Development is to be sited and designed to maximise midwinter solar access to neighbouring properties, having regard to slope, views and existing vegetation.

B3.5 Built form and context ▶ 3.5.2 Overshadowing	
Objectives	Controls
<p>O1 To minimise overshadowing to adjoining properties.</p>	<p>C1 The development is designed so that:</p> <ul style="list-style-type: none"> a) sunlight is provided to at least 50% (or 35m² with a minimum dimension of 2.5m, whichever is the lesser) of the main ground level private open space of adjacent properties for a minimum of 2 hours between 9am and 3pm on 21 June. Where existing overshadowing is greater than this, sunlight is not further reduced; and b) north facing windows to upper level habitable rooms of adjacent dwellings receive at least 3 hours of sun between 9am and 3pm on 21 June over a portion of their surface. <p>C2 Lot orientation may make C1 above difficult to achieve so a reduced amount of solar access may be considered, provided the proposed building complies with all setback controls.</p> <p>Note: For land adjoining open space also refer to Section 3.10.1.</p>

B3.5.3 Public and private views

Views are a special element of Woollahra's unique character. The sloping topography, leafy setting and harbour frontage combine to offer dramatic bushland and water views which contribute to the amenity of both private dwellings and the public domain.

In addition, the municipality's frontage to Sydney Harbour places responsibilities upon the Woollahra community, to ensure development maintains the scenic beauty of the foreshore and headland areas when viewed from the water and from the land.

Public views

Public views from streets, footpaths, parks and other public areas are among Woollahra's most prized assets and are key elements of the municipality's identity.

These views may take the form of discrete views between buildings and vegetation, more open views across the harbour and local landscape from public parks, or more defined vistas along streets terminating at Sydney Harbour or local landmarks. Important views and vistas are identified on the precinct maps in Chapters B1 and B2 in this part of the DCP.

The preservation and, wherever possible, enhancement of public views helps to maintain legibility within Woollahra by allowing people to see and interpret the surrounding landscape and landmark features. Public views also allow Woollahra's scenic beauty and special character to be appreciated.

Private views

View sharing concerns the equitable distribution of views between properties. The view sharing controls in this DCP seek to strike a balance between accommodating new development while providing, where practical, reasonable access to views from surrounding properties.

Development should be designed to reflect the view sharing principles in *Tenacity Consulting v Warringah Council [2004] NSWLEC 140*.

B3.5 Built form and context ▶ 3.5.3 Public and private views

Objectives		Controls	
O1	To protect and enhance existing views and vistas from the public domain.	C1	Development is sited and designed so that the following public views are maintained or enhanced: a) significant views and vistas identified in the precinct maps in this Chapter B1 Residential Precincts and Chapter B2 Neighbourhood HCAs of this DCP; and b) views from other public open space areas, particularly from ridgelines to Sydney Harbour and the Sydney CBD
O2	To provide additional views and vistas from streets and other public spaces where opportunities arise.		

B3.5 Built form and context ▶ 3.5.3 Public and private views

Objectives	Controls
	<p style="text-align: center;">skyline.</p> <p>C2 Vistas along streets are preserved or enhanced through sensitive development location and form.</p> <p>C3 Development on the low side of the street preserves district, iconic and harbour views from the street by:</p> <ul style="list-style-type: none"> a) providing substantial breaks between buildings, front fences, car parking and other structures; and b) incorporating fences with transparent or open end panels at each side boundary to provide for views. <p>C4 Roof forms on the low side of streets are designed to allow public views and add interest to the scenic outlook. Flat expansive roofs with vents, air conditioning units and similar structures are inappropriate.</p>
<p>O3 To encourage view sharing as a means of ensuring equitable access to views from private property.</p>	<p>C5 Development is sited and designed to enable a sharing of views with surrounding private properties, particularly from the habitable rooms (refer to Figures 17 and 18).</p> <p>C6 Development steps down the hillside on a sloping site.</p> <p>C7 The design of the roof form provides for view sharing.</p> <p>C8 Roof terraces are uncovered to provide for view sharing. All elements on roof terraces are to comply with the maximum building height control.</p>

B3.5 Built form and context ▶ 3.5.3 Public and private views

Objectives

Controls

O4 To ensure that views are not compromised by inappropriate landscaping.

C9 The location and species of new tree planting frames and preserves public and private views. Planting must not be used to block views.

C10 In sloping areas, the location of new tree planting frames and preserves public views. This may be achieved:

- a) on the high side of streets—by concentrating new tree planting at the front of buildings within the side setbacks; and
- b) on the low side of streets—by concentrating new tree planting at the front of buildings outside the side setbacks (refer to Figure 18).

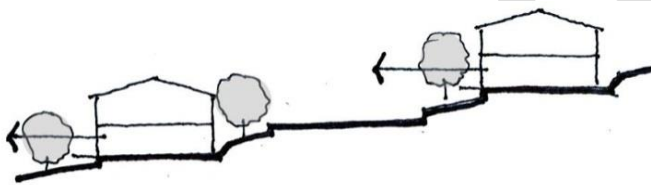

FIGURE 17
View sharing

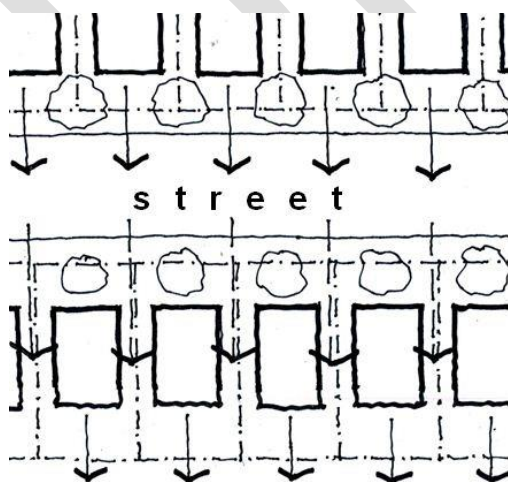

FIGURE 18
Where to locate vegetation to accommodate view paths

B3.5.4 Acoustic and visual privacy

Privacy refers to both acoustic and visual privacy. The privacy needs of residents and neighbours should influence all stages of design, from the location of buildings and the placement of windows and private open space through to the selection of materials and construction techniques.

This section contains objectives and controls for acoustic and visual privacy for buildings that have the potential to impact on adjoining and adjacent residential development.

It is important to note however, that privacy issues are an inherent component of urban living. In many cases some degree of mutual overlooking and/or noise from property to property is unavoidable.

Acoustic privacy

The level of acoustic privacy depends upon the location of habitable rooms relative to noise sources such as habitable rooms, decks, terraces, driveways, air conditioning units, swimming pool pumps and major roads.

Dwellings are designed to ensure adequate acoustic separation and privacy to the occupants of all dwellings. This may be achieved by:

- ▶ ensuring that bedrooms of one dwelling do not share walls with the habitable rooms (excluding bedrooms) or parking areas of the adjacent dwelling;
- ▶ locating bedroom windows at least 3m from streets, shared driveways and parking areas of other dwellings; and
- ▶ separating bedrooms, by way of barriers or distance, from on-site noise sources such as active recreation areas, car parking area, vehicle accessways and service equipment areas.

Visual privacy

The visual privacy controls apply to habitable rooms. This includes rooms such as a bedroom, living room, lounge room, kitchen, dining room and the like. Maintaining visual privacy within and from these types of habitable rooms is most important, as these are the common living areas in a dwelling. The controls also address the private open spaces of dwellings.

The controls establish a hierarchical framework for addressing privacy and overlooking. In this hierarchy glazed fixed windows and windows with high sills are the least preferred option and should only be considered in limited circumstances when all other options have been exhausted.

Note:

- ▶ Under the BCA, habitable rooms exclude a bathroom, laundry hallway, lobby, and other like spaces of a specialised nature occupied neither frequently nor for extended periods.
- ▶ Nothing in this section restricts a person from replacing a window with another window, where the replacement window is in the same location and of the same or a smaller size.

B3.5 Built form and context ▶ 3.5.4 Acoustic and visual privacy

Objectives	Controls
<p>O1 To ensure adequate acoustic privacy for occupants and neighbours.</p>	<p>C1 Dwellings are designed to ensure adequate acoustic separation and privacy to the occupants of all dwellings.</p> <p>C2 Dwellings located close to high noise sources, such as a busy road or railway line are to:</p> <ul style="list-style-type: none"> a) be designed to locate habitable rooms and private open space away from the noise source; and b) include sound attenuation measures, such as acoustic glazing and insulation. <p>Note: Shared walls and floors between dwellings must be designed in accordance with the sound transmission and insulation criteria of the Building Code of Australia.</p> <p>C3 Electrical, mechanical, hydraulic and air conditioning equipment is housed so that it does not create an ‘offensive noise’ as defined in the Protection of the <i>Environment Operations Act 1997</i> either within or at the boundaries of any property at any time of the day.</p>
<p>O2 To ensure adequate visual privacy for occupants and neighbours while balancing the need to provide for reasonable levels of environmental amenity, including access to sunlight and ventilation, and good architectural outcomes.</p>	<p>C4 New windows in habitable rooms are designed to prevent a direct sightline to the habitable room windows or private open space of an adjacent dwelling within 9m.</p> <p>This may be achieved by options including, but not limited to (in order of preference):</p> <ul style="list-style-type: none"> a) Window location—primary windows to habitable rooms are located and designed to provide an outlook to the front and rear setbacks, not the side boundaries. b) Layout and separation—offsetting windows from the windows/private open spaces of the adjoining dwelling to limit views between the windows/private open space. c) Architectural design solutions and devices—redirecting and limiting sightlines using deep sills with planter

B3.5 Built form and context ▶ 3.5.4 Acoustic and visual privacy

Objectives

Controls

boxes, fixed horizontal or vertical louvres, or other screening devices set off the windows internally or externally.

d) Glazed opening windows—using windows with translucent glazing to a height of 1.5m above floor level and fitted with a winder mechanism to control the maximum angle of the opening to limit views.

e) Glazed fixed windows or high sills—using fixed windows with translucent glazing in any part of the window below 1.5m above floor level, or window sill heights of 1.5m above floor level.

Note: Applicants may be required to demonstrate how privacy impacts are resolved by way of view line diagrams, photographs and other suitable means.

C5 Windows to bathrooms and toilet areas have translucent glazing where these have a direct view to, and from, habitable rooms and private open space on adjoining and adjacent properties.

C6 Architectural design solutions and screening devices referred to in C4 (c) above are integrated with the overall design and contribute to the architectural merit of the building, having particular regard to:

- a) aesthetics of the building including impacts on visual bulk;
- b) compliance with minimum boundary setback controls;
- c) appearance from adjoining properties; and
- d) views from adjoining or adjacent properties.

B3.5 Built form and context ▶ 3.5.4 Acoustic and visual privacy

Objectives

Controls

O3 To minimise the impacts of private open space areas when located above ground level area.

C7 Balconies, decks, terraces including roof terraces, and the like, within a development are suitably located and screened to prevent direct views into habitable rooms (including bedrooms) or private open space of the adjoining and adjacent dwellings.

C8 For a dwelling house, dual occupancy, semi-detached dwelling, or attached dwelling—the acceptability of any elevated balcony, deck, or terrace will depend on the extent of its impact, its reasonableness and its necessity.

Note: Refer to *Super Studio vs Waverley Council, (2014) NSWLEC 91*

C9 Windows and balconies of an upper-level dwelling are designed to prevent overlooking of the private open space of a dwelling below within the same development.

C10 The trafficable area of a roof terrace or upper level decks (above the second storey) is setback so that there is no direct line of sight, from that part of the building where the terrace or deck is, to:

- a) neighbouring private open space within 12m; or
- b) windows of habitable rooms in neighbouring dwellings within 12m.

C11 Lighting installations on a roof terrace or upper level deck are:

- a) contained within the roof terrace area and located at a low level; or
- b) appropriately shaded and fixed in a position so light is projected downwards onto the floor surface of the terrace.

Note: Lighting of roof terraces must be designed in compliance with *Australian Standards 4282-1997 Control of obtrusive effects of outdoor lighting*.

B3.5 Built form and context ▶ *3.5.4 Acoustic and visual privacy*

Objectives

Controls

O4 To ensure that where roof terraces are inserted into existing roofs, they do not impact on the roof profile.

C12 For a roof terrace within the existing roof a building:

- a) no part of the roof terrace or associated structures, such as a balustrade, projects beyond the roof profile; and
- b) the roof terrace and opening within the roof are clearly subservient in form and size when compared with the roof plane in which they are located.

DRAFT

B3.6 On-site parking

On-site parking, including garages, carport, hardstand areas and driveways, must be carefully designed to not detract from the appearance of the development and the streetscape.

In particular, on-site parking should not dominate the street frontage, and driveway openings should be limited to protect pedestrian safety and to preserve streetscape amenity such as trees and on-street parking. On-site parking should also be designed to limit the extent of impervious surfaces and excavation and to allow landscaped area in the front setback.

Note: The number of on-site parking spaces for a development is set out in Part E, Chapter E1 Parking and Access.

B3.6 On-site parking	
Objectives	Controls
O1 To minimise the visual impact of garages, car parking structures and driveways on the streetscape.	C1 On-site parking is designed and located so that it: <ul style="list-style-type: none"> a) does not dominate the street frontage; b) preserves significant trees and vegetation; and c) is located within the building envelope.
O2 To ensure that on-site parking does not detract from the streetscape character and amenity.	C2 For garages facing the street frontage—the maximum garage width is no greater than 40% of the site frontage width or 6m, whichever is the lesser.
O3 To minimise loss of on-street parking.	C3 Where possible on-site parking is to be accessed from the rear. The width of parking structures can occupy 75% of the rear frontage or 6m (whichever is the lesser). The area of the parking structure can be no greater than 40m ² and a maximum of 3.6m high.
	C4 Where there is no rear lane access, on-site parking is located within the building envelope.
	C5 Development involving three or more dwellings provides basement parking.

B3.6 On-site parking	
Objectives	Controls
<p>O4 To facilitate on-site parking on steeply sloping sites.</p>	<p>C6 Notwithstanding C4, garages may be located in the front setback (i.e. outside the building envelope) where:</p> <ul style="list-style-type: none"> a) the rise or fall measured to a distance of 7m from the street frontage is greater than 1 in 3; and b) the garage is incorporated into a podium or street wall; and c) the garage is not more than 40m² in area. <p>C7 For garages located in the front setback, the maximum height of the garage structure is 2.7m above the footpath level. If the existing height of the retaining/street wall or the two adjoining garages structures is higher than 2.7m, that greater height may be permitted (refer to Figure 19).</p> <p>C8 For garages on the high side of the street—balustrading to trafficable areas on top of the garage is setback at least 1m from the front boundary, and is of an open or transparent form (refer to Figure 20).</p>
<p>O5 To ensure that on-site parking is designed and integrated with the principal building on the site.</p>	<p>C9 For separate structures, the roof form, materials and detailing complement the principal building.</p>
<p>O6 To ensure that on-site parking does not detract from the streetscape character and amenity.</p>	<p>C10 Garage doors are designed to complement the building design and any important character elements within the street.</p> <p>C11 Materials characteristic of the street are used for new structures at the street edge.</p>

B3.6 On-site parking

Objectives	Controls
<p>07 To minimise the visual and environmental impacts of driveways and other hard stand areas associated with car parking.</p>	<p>C12 The width of driveways is minimised. Generally the width is no more than the minimum width required to comply with the relevant Australian Standards (see Section E1).</p> <p>C13 Only one driveway entrance is provided. For example, development involving more than one dwelling shares the driveway access.</p> <p>C14 Where soil and drainage conditions allow, semi-porous surfaces are used for uncovered car parking and driveway areas to facilitate on-site stormwater infiltration and reduce limit the visual impact of hard-surface areas.</p>

DRAFT

FIGURE 19
Garaging in front setback

On sites where the gradient measured to a distance of 7m (A) from the street frontage is greater than 1 in 3 (B), Council may permit garages forward of the building line if incorporated into a podium/street wall.

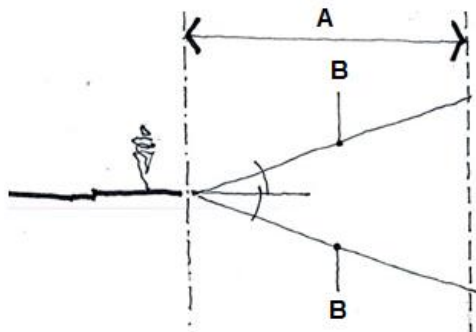
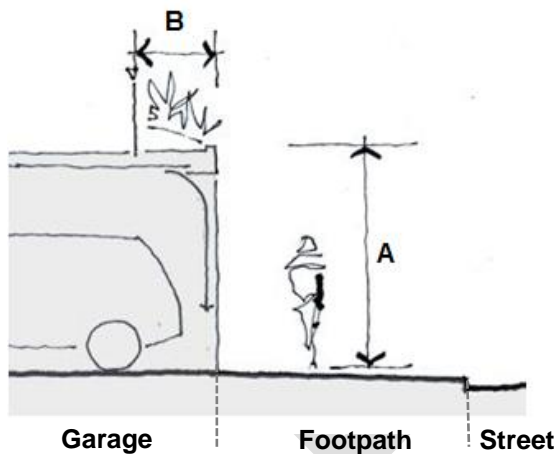

FIGURE 20
Garaging at front boundary

A = The garage height at the front boundary is to be no more than 2.7m above the pavement
B = Any balustrading on the garage is to be set back 1m



B3.7 External areas

B3.7.1 Landscaped areas and private open space

Open space and landscaping play important roles in the preservation of wildlife habitat, the establishment of community identity, the provision of recreation opportunities and stormwater management.

Private open space

Private open space contributes towards the amenity of individual dwellings and should be clearly delineated from public and communal areas. Private open space may be provided at or above ground level. Above ground open space may comprise balconies or rooftop areas.

Communal open space

Communal open space comprises shared open space available for use by all residents of a housing development. Communal open space may include landscaped areas, swimming pools or tennis courts and is typically controlled by a body corporate.

Landscaping

Landscaped area is defined in Woollahra LEP 2014 to mean “a part of a site used for growing plants, grasses and trees, but does not include any building, structure or hard paved area”.

Deep soil landscaped area is the part of a site that contains landscaped area which has no above ground, ground level or subterranean development.

Landscaped areas within developments may comprise both communal and private open space areas. Landscape treatment helps to determine the amenity of individual dwellings, define private and public areas, reinforce or screen views and define streetscape character.

The amount and composition of landscaped area also plays an important role in stormwater management, the energy efficiency of developments and access to sunlight. Existing trees and vegetation may support significant indigenous wildlife populations and habitat.

B3.7 External areas ▶ 3.7.1 Landscaped area and private open space

Objectives		Controls	
01	To ensure that the areas outside the footprint contribute to the desired future character of the location.	C1	For development in the R2 and R3 residential zones—at least 40% of the site area outside the footprint is deep soil landscaped area.
02	To provide sufficient deep soil landscaped area to support substantial vegetation.	C2	At least 40% of the front setback comprises deep soil landscaped area, and:
03	To provide for on-site stormwater absorption.		a) for a residential flat building or multi dwelling housing in the Wallaroy, Manning Road, Darling Point, Bellevue Hill South, Bellevue Hill North or Rose Bay precinct—at least one consolidated area of the deep soil area is at least 20m ² ; and
			b) for a residential flat building or multi dwelling housing in the Double Bay or Point Piper precinct—at least one consolidated area of the deep soil area is at least 12m ² .
		C3	Control C2 above does not apply to land in Rose Bay between Caledonian Road and Vickery Avenue zoned R3 Medium Density Residential.
		C4	At least 50% of the rear setback comprises deep soil landscaped area.
		C5	The deep soil landscaped area is free of garaging, paving, outbuildings, tennis courts, swimming pools, above ground and below ground structures including stormwater works.
04	To ensure the adequate provision of accessible and useable primary open space.	C6	For a dwelling house—a primary open space area of at least 35m ² is provided.
		C7	For each dwelling within a semi-detached dwelling, dual occupancy or attached dwelling—a primary open space area of at least 35m ² is provided.
		C8	The primary open space area in C6 and C7 above has a gradient of no more than 1 in 10 (refer to Figure 21).
		C9	Excavation is permitted to achieve the required level area of primary open space

B3.7 External areas ▶ *3.7.1 Landscaped area and private open space*

Objectives	Controls
	<p>up to 1.2m from existing ground level (refer to Figure 21).</p> <p>C10 Part of the primary open space area is directly accessible from a habitable room.</p>
<p>O5 To ensure that dwellings in residential flat buildings and multi dwelling housing are provided with adequate private open space that enhances the amenity of the dwellings.</p>	<p>C11 For residential flat building or multi dwelling housing—each dwelling is provided with private open space which has a minimum area of 8m² and minimum dimensions of 2m x 2m. For dwellings above ground level, this may be in the form of a balcony, verandah or uncovered roof terrace and the like.</p>
<p>O6 To ensure that private open space areas are well-designed.</p>	<p>C12 Development takes advantage of opportunities to provide north facing private open space to achieve comfortable year round use.</p> <p>C13 Private open space is clearly defined for private use through planting, fencing or landscape features.</p> <p>C14 The location of private open space: <ul style="list-style-type: none"> a) takes advantage of the outlook and natural features of the site; b) reduces the adverse privacy and overshadowing impacts; and c) addresses surveillance and privacy where private open space abuts public space. </p> <p>C15 A roof terrace and associated structures will only be considered where the size, location and design of the terrace meets the requirements in Section 3.5.4 Acoustic and visual privacy.</p>

B3.7 External areas ▶ 3.7.1 Landscaped area and private open space

Objectives	Controls
07 To retain important existing mature trees, vegetation and other landscape features.	C16 Existing significant trees and vegetation are incorporated into the landscape area and treatment.
08 To protect or enhance indigenous wildlife populations and habitat through appropriate planting of indigenous vegetation species.	C17 Native species are preferred, and landscape designs are encouraged to provide at least 50% of the plants as native species.
09 To ensure that landscaping contributes positively to the streetscape and the amenity of adjoining residents.	C18 Landscaping provides for a diversity of native species and a complexity of habitat through vertical layering.
010 To ensure that landscaping allows view sharing.	Note: Vertical layering, by planting a variety of vegetation in different sizes and heights provides more cover and feeding opportunities for wildlife species.
	C19 Landscaping facilitates the linking of open space reserves through wildlife corridors and reduces habitat fragmentation and loss.
	C20 The landscape design: <ul style="list-style-type: none"> a) uses vegetation types and landscaping styles which contribute to the streetscape and desired future character objectives for the locality; b) uses vegetation types that will not block views; c) does not adversely affect the structure of the proposed building or buildings on adjoining properties; d) considers personal safety by ensuring good visibility along paths and driveways and avoiding shrubby landscaping near thoroughfares; e) contributes to energy efficiency and amenity by providing substantial shade in summer, especially to west facing windows and open car park areas and admitting winter sunlight to outdoor and living areas and other habitable rooms; f) improves privacy between dwellings;

B3.7 External areas ▶ 3.7.1 Landscaped area and private open space

Objectives

Controls

- g) minimises risk of damage to overhead power lines and other services; and
- h) provides adequate sight lines for vehicles and pedestrians, especially near street corners and intersections.

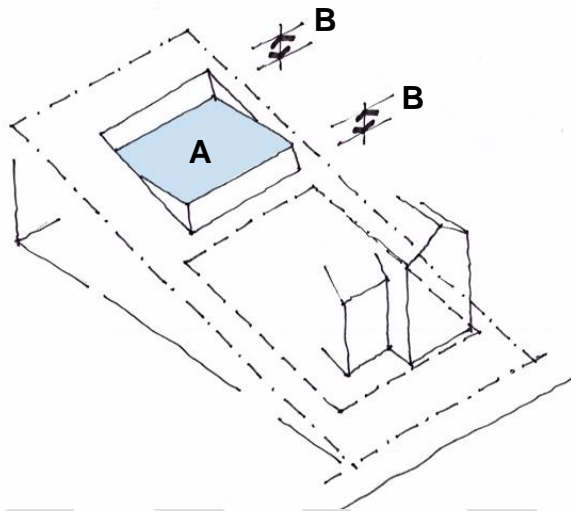

FIGURE 21

Provision of level area of primary open space

A = Minimum area 35m², maximum gradient 1:10

B = Primary open space is to be no more than 1.2m above or below existing ground level

B3.7.2 Fences

Fences and walls play major roles in determining the appearance of developments and their contribution towards the streetscape. Carefully designed fences and walls help to integrate developments into the existing streetscape. However, when poorly designed they can unduly dominate the streetscape and reduce opportunities for neighbourhood surveillance and social interaction.

This DCP seeks to recognise both the importance of fences and walls to the privacy and security enjoyed by individual properties and the potential of fences and walls to contribute to creating or enhancing attractive streetscapes.

B3.7 External areas ► 3.7.2 Fences	
Objectives	Controls
O1 To ensure fences and walls improve amenity for existing and new residents and contribute positively to streetscape and adjacent buildings.	C1 Fencing is designed and located to protect the inhabitants of the property, and allows for casual surveillance from the building to the street.
O2 To ensure that fences and walls are not visually intrusive in the streetscape and to enhance pedestrian safety.	C2 The arrangement of built form, fences, landscaping and other features clearly defines any public, common, and private space.
O3 To ensure that fences and walls do not unreasonably restrict views and vistas from streets and other public spaces.	C3 Front fences and walls assist in defining building entrances.
O4 To ensure that development creates well defined areas of public and private space.	C4 The height of front fences does not exceed: <ul style="list-style-type: none"> a) 1.2m if solid; or b) 1.5m if 50% transparent or open; unless otherwise specified in the precinct controls in Chapters B1 and B2 of this part of the DCP. <p>Note: Chapters B1 and B2 define the desired future character for each precinct, and identify any special heritage, streetscape character and key elements within each precinct.</p>
	C5 Fences and gates on the low side of the street adjacent to each side boundary incorporate transparent or open panels to preserve district, iconic and harbour views from the street.

B3.7 External areas ▶ **3.7.2 Fences**

Objectives	Controls
	<p>C6 On the high side of streets where there is an increase in ground level in excess of 1.2m on the property side of the street alignment—the height of front fences and walls may increase to 1.2m from the level of the high side (refer to Figure 22).</p> <p>C7 Gates do not encroach over the street alignment when opening or closing.</p> <p>C8 Where a vehicular entrance is proposed in conjunction with a fence of height greater than 1.2m—a 45° splay or its equivalent is provided either side (as applicable) of the entrance to ensure driver and pedestrian vision. The splay is to have minimum dimensions of 2m x 2m (refer to Figure 23).</p>
<p>O5 To ensure boundary fences between sites provide visual privacy without affecting the amenity of those sites in terms of views and sunlight.</p>	<p>C9 The rear and side fences:</p> <ul style="list-style-type: none"> a) are located behind the building front setback; and b) do not exceed 1.8m on level sites, or 1.8m as measured from the low side where there is a difference in level either side of the boundary. <p>C10 Where there is a difference in ground level in excess of 1.2m either side of the boundary—the height of fences and walls may increase to 1.2m from the level of the high side (refer to Figure 24).</p>
<p>O6 To ensure fences and walls are sympathetic to the topography.</p>	<p>C11 For sloping streets—the height of fences and walls may be averaged and fences and walls may be regularly stepped.</p>

B3.7 External areas ► 3.7.2 Fences

Objectives	Controls
<p>07 To protect and retain fences and walls that are important character elements for the precinct.</p>	<p>C12 Remnant sandstone and garden walls are retained and adequately maintained.</p>
<p>08 To ensure materials used in fences and walls are a high quality and in keeping with the existing streetscape character and character of the building.</p>	<p>C13 Existing retaining walls that are important character elements in the street or precinct are retained.</p>
	<p>C14 Existing fences, particularly those constructed from sandstone, that are significant or represent important character elements in the street or precinct are retained.</p>
	<p>C15 The design and materials of front fences and walls are compatible with those fences and walls that contribute positively to the streetscape, (and the heritage context in the case of heritage conservation areas), and satisfy the desired future character and precinct controls in Chapters B1 and B2 of this DCP.</p>
	<p>C16 Fences and walls made from corrugated iron, barbed wire, and the like are not permitted.</p>

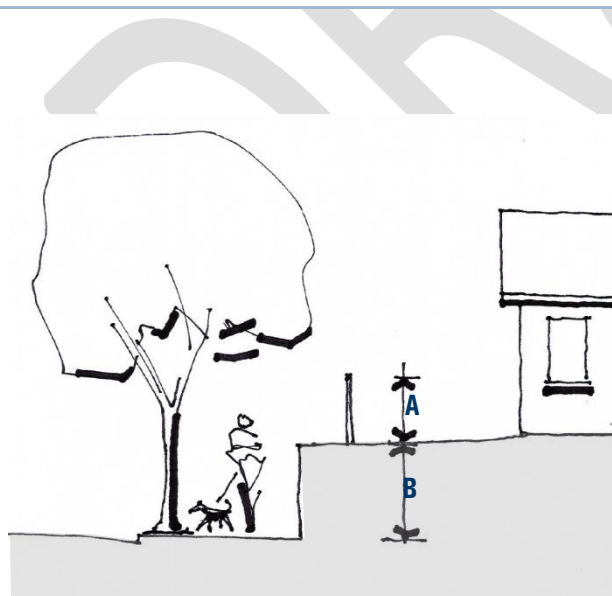

FIGURE 22
 Front fences on the high side of streets
A = 1.2m maximum
B = Increase in ground level greater than 1.2m

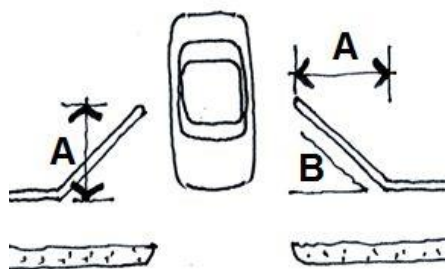

FIGURE 23
Splays for driveway entrances where fence height exceeds 1.2m

A = 2m minimum

B = 45° splay

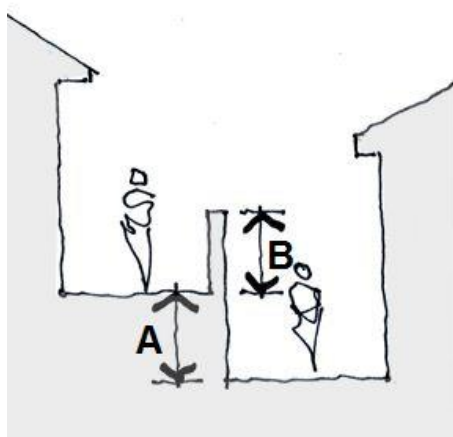

FIGURE 24
Side and rear boundary fences where levels change between properties

A = Increase in ground level greater than 1.2m

B = 1.2 maximum

B3.7.3 Site facilities

Some site facilities including mail boxes, clothes drying areas and laundry facilities are essential or common features in contemporary residential development. Others such as radio aerials and satellite dishes are less frequently required. The potential impacts of site facilities on the overall appearance of developments and the local streetscape need to be considered.

B3.7 External areas ▶ 3.7.3 Site facilities

Objectives		Controls	
O1	To ensure that mail boxes are suitably located and designed.	C1	Lockable mail boxes are provided close to the street and are integrated with front fences or building entries.
O2	To provide adequate storage facilities in residential development.	C2	Lockable storage space of at least 8m ³ per dwelling is provided.

B3.7 External areas ▶ 3.7.3 Site facilities

Objectives		Controls	
O3	To encourage the use of natural resources to dry clothes.	C3	Development that includes a residential component provides opportunity for at least one external clothes drying area.
O4	To ensure external clothes drying areas are suitably located.	C4	External clothes drying areas have access to sunlight, and are located in a secure place away from public spaces and screened from public view. Note: External drying areas may be located in the deep soil landscaped area.
O5	To ensure that aerials, antennae, and communications dishes must be thoughtfully integrated into development and are unobtrusive.	C5	Developments involving three or more dwellings share one common television antennae or satellite dish.
		C6	The design and location of aerials, antennae, and communications dishes: <ul style="list-style-type: none"> a) do not have an unreasonable impact on the architectural character of the building to which it is attached; b) are not visually intrusive within the streetscape; and c) do not have an unreasonable impact on the amenity of adjoining and adjacent properties.

B3.7 External areas ▶ 3.7.3 Site facilities

Objectives	Controls
<p>O6 To ensure that air-conditioning units, including external condensers, do not have adverse streetscape or amenity impacts.</p>	<p>C7 Air-conditioning units are not be visible from the streetscape or public domain.</p> <p>C8 Air-conditioning units do not unreasonably impact on the visual or acoustic amenity of adjoining properties. The impact on neighbours is less than the impact on the occupants of the site where the air-conditioning unit is located.</p> <p>C9 Air conditioning units are suitably enclosed or screened to minimise noise impacts to adjoining properties.</p> <p>Note: Noise emissions from air-conditioning units must not exceed the background noise levels when measured at the boundary of the development site. The provisions of the <i>Protection of the Environment Operations Act 1997</i> apply.</p>
<p>O7 To protect the air quality and residential amenity.</p>	<p>C10 New fireplaces burn non-solid fuels, e.g. gas or electricity.</p>
<p>O8 To ensure that development incorporates adequate garbage and recycling collection areas.</p>	<p>C11 Refer to Part E of the DCP, Chapter E5 Waste Management.</p>

B3.7.4 Ancillary development – swimming pools, tennis courts and outbuildings

Swimming pools

A swimming pool is an impermeable structure capable of holding water to a depth greater than 300mm for swimming or other recreation purposes, but does not include a spa pool.

B3.7 External areas ▶ 3.7.4 Ancillary development - swimming pools

Objectives	Controls
O1 To provide for recreational opportunities for swimming without compromising the amenity of the adjoining properties.	C1 The swimming pool does not occupy the deep soil landscaped area.
O2 To limit excavation.	C2 Excavation beyond the controls in Section B3.4 is permitted to accommodate a backyard swimming pool, where the pool is outside the building envelope. Note: This concession does not apply to a swimming pool in a basement area.
	C3 The swimming pool (measured from the outer edge including pool coping) is at least 1.5m from property boundaries.
	C4 The swimming pool surrounds are no more than 1.2m above or below the existing ground level.
	C5 The swimming pool is no deeper than 2m from the pool surround level (refer to Figure 25).
	C6 The location and design of the swimming pool and associated works do not adversely impact on prescribed trees (refer to Chapter E3 Tree Management).

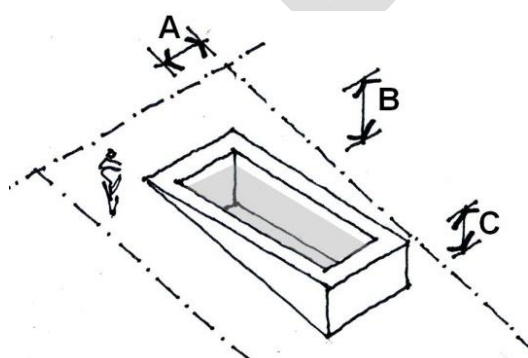

FIGURE 25
Provision of private swimming pools

- A is a minimum of 1.5m
- B = pool depth is a maximum of 2m
- C is to be a maximum of 1.2m

Tennis courts

Tennis courts are rectangular recreational areas, approximately 24m x 11m, with a low net stretched across the centre. They are usually fenced to retain balls on the court during play.

B3.7 External areas ▶ 3.7.4 Ancillary development - tennis courts	
Objectives	Controls
O1 To provide recreational opportunities for playing tennis without compromising the amenity of adjoining and adjacent properties.	C1 The tennis court level is a maximum of 1.2m above or below the existing ground level (refer to Figure 26).
O2 To limit excavation.	C2 The tennis court is at least 1.5m from property boundaries (refer to Figure 26).
	C3 The court playing surface is made from a material that minimises light reflection.
	C4 The height and location of court fencing does not unreasonably compromise: <ul style="list-style-type: none"> a) sharing of views from surrounding properties; or b) solar access to adjoining properties.
	C5 Fencing material is a recessive colour.
	C6 Where floodlighting is proposed, the lighting does not unreasonably impact on the amenity of adjoining or adjacent properties.
	C7 The location of the tennis court and associated works does not adversely impact on prescribed trees (refer to Chapter E3 Tree Management).

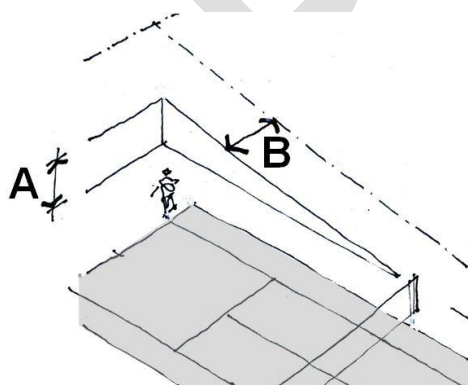

FIGURE 26
Provision of private tennis courts on residential sites

A is to be a maximum of 1.2m

B is to be a minimum of 1.5m

Outbuildings

Although development outside the building envelope is generally not permitted, small outbuildings such as a cabana, cubby house, fernery, garden shed, gazebo, greenhouse or the like, may be located within the rear the setback.

B3.7 External areas ▶ 3.7.4 Ancillary development - outbuildings	
Objectives	Controls
<p>O1 To ensure that outbuildings do not unreasonably compromise the amenity of the occupants or the adjoining properties.</p>	<p>C1 The outbuilding is located within the building envelope or the rear setback.</p> <p>C2 Maximum height of the outbuilding is 3.6m.</p>
<p>O2 To ensure that the required deep soil landscaped area and level area of private open space are achieved.</p>	<p>C3 The outbuilding, if located outside the building envelope, does not reduce the deep soil landscaped area and the private open space areas below the minimum required for development, as specified in Section 3.7.1 Landscaped areas and private open space.</p>



B3.8 Additional controls for development other than dwelling houses

This section includes additional controls for the following types of development:

- ▶ secondary dwellings;
- ▶ semi-detached dwellings;
- ▶ dual occupancies;
- ▶ attached dwellings;
- ▶ residential flat buildings and multi-dwelling housing;
- ▶ Inter-War flat buildings; and
- ▶ post-1950s residential towers.

These controls apply in addition to the controls in Sections B3.2-B3.7.

B3.8.1 Minimum lot width

The minimum lot width, as measured from the street frontage, is the minimum required to accommodate development on a site.

The controls below apply to detached dual occupancies, attached dwellings, residential flat buildings and multi dwelling housing, recognising that these forms of development require a minimum width to ensure that each dwelling in the development can be designed to provide reasonable amenity having regard to issues such as privacy, building separation and open space.

B3.8 Additional controls ▶ 3.8.1 Minimum lot width

Objectives	Controls
<p>O1 To ensure that sites have a minimum width to provide for the amenity of occupants and adjoining properties.</p>	<p>C1 The parent lot has a minimum width at the street front alignment as follows:</p> <ul style="list-style-type: none"> a) detached dual occupancy—21m; b) attached dwellings—24m; c) residential flat building or multi dwelling housing containing three dwellings—15m; and d) residential flat building or multi dwelling housing containing four or more dwellings—21m. <p>Notes:</p> <ul style="list-style-type: none"> a) No minimum lot width applies to a dwelling house, semi-detached dwelling or attached dual occupancy. b) The parent lot refers to the development site before any subdivision (if relevant). c) These controls do not apply to battle-axe lots (refer to Section B3.9).

B3.8.2 Secondary dwellings

Under Woollahra LEP 2014, secondary dwelling means a self-contained dwelling that:

- a) is established in conjunction with another dwelling (the principal dwelling);
- b) is on the same lot of land as the principal dwelling; and
- c) is located within, or is attached to, or is separate from, the principal dwelling.

Clause 5.4 of Woollahra LEP 2014 sets the maximum size of a secondary dwelling, being 60m², or not more than 5% of the total floor area of the principal dwelling.

B3.8 Additional controls for development other than dwelling houses

▶ 3.8.2 Secondary dwellings

Objectives	Controls
<p>O1 To ensure that amenity is provided to the occupants of the principal dwelling, secondary dwelling and to adjoining properties.</p>	<p>C1 The secondary dwelling is located within the building envelope and is calculated in the footprint.</p> <p>Note: Only a secondary dwelling approved under the <i>State Environmental Planning Policy (Affordable Rental Housing) 2009</i> may be located outside the building envelope.</p> <p>C2 Both the principal and secondary dwellings have direct access to private open space.</p>

B3.8.3 Semi-detached dwellings

Under Woollahra LEP 2014, a semi-detached dwelling means a dwelling that is on its own lot of land and is attached to only one other dwelling (refer to Figure 27).

This section includes controls relating to:

- ▶ new semi-detached dwelling development; and
- ▶ alterations and additions to existing semi-detached dwellings.

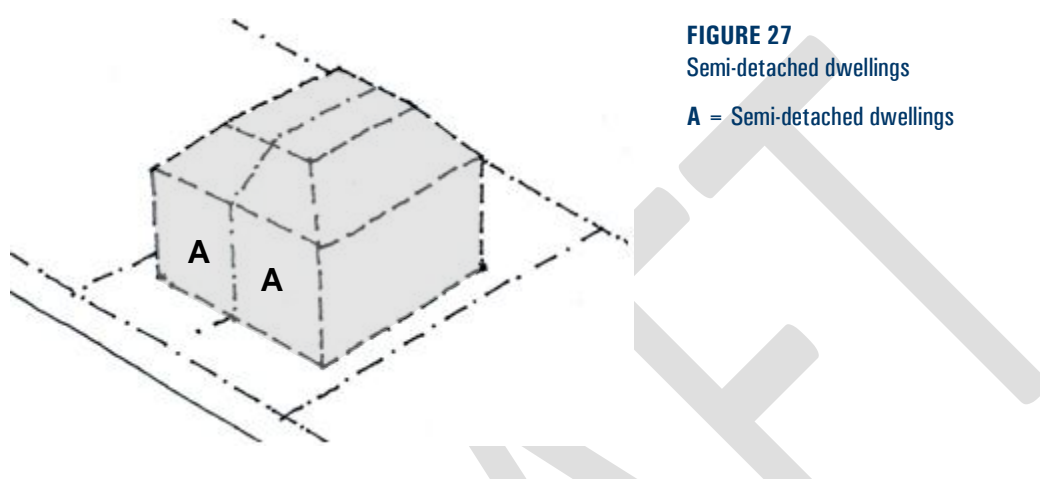

FIGURE 27
Semi-detached dwellings
A = Semi-detached dwellings

B3.8 Additional controls for development other than dwelling houses	
▶ 3.8.3 Semi-detached dwellings	
Objectives	Controls
For new development	
O1 To encourage semi-detached dwellings to present as a uniform built form.	C1 Both dwellings in the development have an integrated design and are complementary to each other in terms of style, design, materials, roof form and colour scheme.
For alterations and additions to existing semi-detached development	
O2 To ensure that a proposal to redevelop one semi-detached dwelling in a pair does not adversely affect the development potential of the unaltered dwelling.	C2 Alterations and additions to one semi-detached dwelling in a pair do not unreasonably prevent the redevelopment of the remaining semi-detached dwelling at a later date.
	C3 Windows facing the common elevation between each semi-detached dwelling are avoided.
O3 To ensure that the original streetscape	C4 First floor additions are set back beyond

B3.8 Additional controls for development other than dwelling houses

3.8.3 Semi-detached dwellings

Objectives	Controls
<p>contribution and character of semi-detached dwellings is retained and enhanced.</p>	<p>the apex or main ridge of the existing principal roof form.</p> <p>C5 Existing chimneys are retained.</p> <p>C6 Dormers are not located in the street elevation of the building.</p> <p>C7 The key architectural elements of the original building are retained.</p>
<p>O4 To ensure that additions and alterations to one semi-detached dwelling respects the scale, detailing and characteristics of the pair.</p>	<p>C8 Alterations and additions to one of a pair of semi-detached dwellings does not dominate or compromise the uniformity or geometry of the principal or street front elevation.</p> <p>Where symmetry is the dominant characteristic it should be respected; where asymmetry gives the appearance of a single building this should be respectfully acknowledged in the design to maintain that character.</p> <p>C9 The style, pitch, material, profile and colour of the proposed roof form matches, complements and extends the existing roof form of the building. Uncharacteristic roof forms and details that detract from the character of the adjoining semi-detached dwelling are avoided.</p> <p>C10 Roof design does not adversely impact on the adjoining semi-detached dwelling or create stormwater spillover.</p> <p>C11 External colour schemes and materials are sympathetic to the character of the original building and the other semi-detached dwelling.</p>

B3.8.4 Dual occupancy

A dual occupancy means two dwellings on one lot of land (refer to Figure 28).

Under Woollahra LEP 2014, dual occupancies are defined as:

- ▶ **dual occupancy (attached)** means two dwellings on one lot of land that are attached to each other, but does not include a secondary dwelling.
- ▶ **dual occupancy (detached)** means two detached dwellings on one lot of land, but does not include a secondary dwelling.

Clause 4.1A of Woollahra LEP 2014 sets the minimum lot size of dual occupancies.

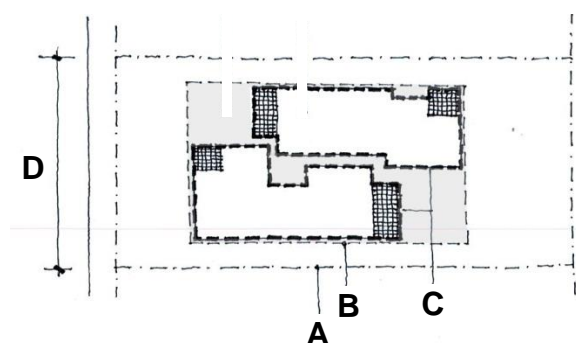

FIGURE 28
Example layout of detached dual occupancy within the building envelope

- A = Lot boundary
- B = Building envelope
- C = Extent of building
- D = 21m minimum frontage

B3.8 Additional controls for development other than dwelling houses

▶ 3.8.4 Dual occupancy

Objectives	Controls
O1 To ensure that the development presents as an integrated design.	C1 Both dwellings in the development complement each other in terms of style, design, materials, roof form and colour scheme.
O2 To ensure useable and well located areas of private open space.	C2 Private open space areas are not located within the front setback area.
	C3 Each dwelling has direct access to its own private open space area.
	C4 Private open space areas are not overlooked by the other dual occupancy dwelling in the development.

<p>O3 To ensure that on-site parking does not detract from the streetscape character and amenity.</p>	<p>C5 Both dual occupancies share a common driveway cross-over. Separate cross overs may be considered on corner lots, where the access is from separate streets.</p>
<p>O4 To minimise loss of on-street parking.</p>	

B3.8.5 Attached dwellings

Under Woollahra LEP 2014, attached dwelling means a building containing three or more dwellings, where:

- a) each dwelling is attached to another dwelling by a common wall;
- b) each of the dwellings is on its own lot of land; and
- c) none of the dwellings are located above any part of another dwelling.

Refer to Figure 29.

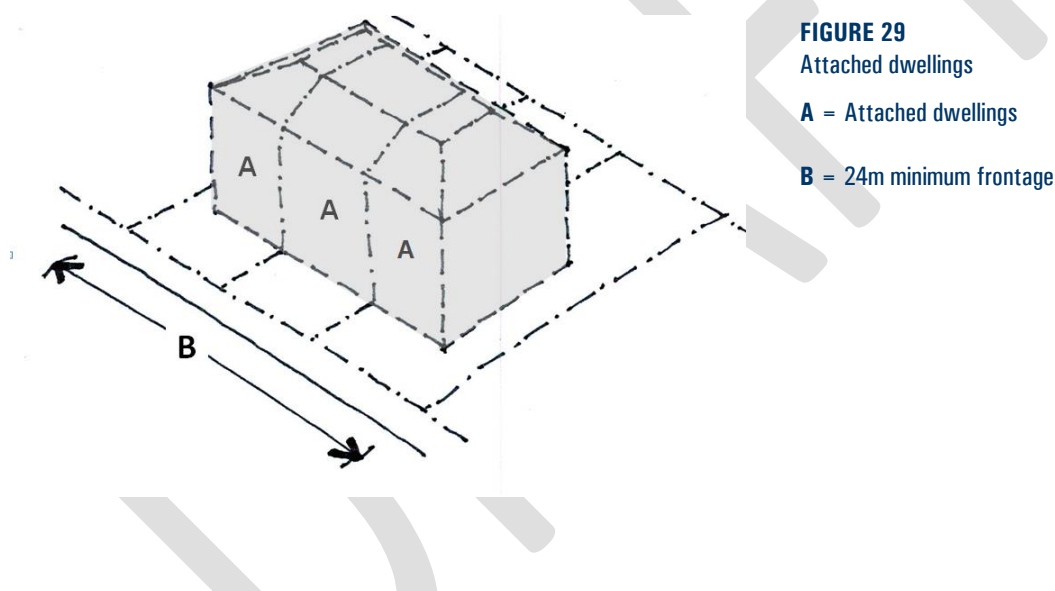

FIGURE 29
Attached dwellings
A = Attached dwellings
B = 24m minimum frontage

B3.8 Additional controls for development other than dwelling houses	
▶ 3.8.5 Attached dwellings	
Objectives	Controls
<p>O1 To ensure that the development presents as an integrated design.</p>	<p>C1 All dwellings in the development complement each other in terms of style, design, materials, roof form and colour scheme.</p>
<p>O2 To ensure that on-site parking does not detract from the streetscape character</p>	<p>C2 If basement parking is not provided, at grade parking is located at the rear. Parking structures addressing the street</p>

and amenity. are not encouraged.

B3.8.6 Residential flat buildings and multi dwelling housing

Woollahra LEP 2014 defines the following types of residential accommodation:

- ▶ **residential flat building** means a building containing three or more dwellings, but does not include an attached dwelling or multi dwelling housing.
- ▶ **multi dwelling housing** means three or more dwellings (whether attached or detached) on one lot of land, each with access at ground level, but does not include a residential flat building.

In addition to the DCP controls, the NSW Government’s *State Environmental Planning Policy No. 65 - Design Quality of Residential Flat Development* (SEPP 65) is also a mandatory consideration for all applications for residential flat buildings and multi dwelling housing that is three or more storeys and contains four or more self-contained dwellings.

SEPP 65 contains principles for good design and provides guidance for evaluating the merit of design solutions, and is supported by the Residential Flat Design Code. The Code contains detailed information about how development proposals can achieve the design quality principles in the SEPP, addressing matters such as building separation and building configuration.

Where SEPP 65 applies, the development application must be accompanied by a design verification from a qualified designer, confirming that:

- ▶ he or she designed, or directed the design, of the development; and
- ▶ the design quality principles set out in SEPP 65 are achieved for the development.

B3.8 Additional controls for development other than dwelling houses

▶ 3.8.6 Residential flat buildings and multi dwelling housing

Objectives	Controls
<p>O1 To ensure that dwellings within the development provide good amenity.</p>	<p>C1 Internal layout and window placement achieves good natural ventilation.</p> <p>C2 Single aspect dwellings are limited in depth to 8m from a window.</p> <p>C3 The back of the kitchen is no more than 8m from a window.</p> <p>C4 The width of a cross-over or cross-through dwelling over 15m deep is 4m or greater. Deep and narrow dwelling layouts are avoided.</p> <p>C5 Where practical, habitable rooms excluding bedrooms are oriented to the</p>

B3.8 Additional controls for development other than dwelling houses

▶ **3.8.6 Residential flat buildings and multi dwelling housing**

Objectives	Controls
	<p>north for maximum solar access.</p> <p>C6 Light wells as the main source of lighting and ventilation to dwellings is avoided.</p>
<p>O2 To ensure useable and well located areas of private open space that provide good amenity for residents.</p>	<p>C7 Each dwelling has direct access to its own private open space area.</p> <p>C8 Private open space areas are located and designed to minimise overlooking from other dwellings in the development.</p> <p>Note: For requirements for adaptable housing in residential flat buildings and mixed use developments refer to Part E8 of the DCP.</p>

DRAFT

B3.8.7 Inter-War flat buildings

Inter-War flat buildings were constructed in many parts of the Woollahra LGA. Many of these buildings make an important historic, aesthetic, social and technical contribution to the character of areas and to the historical development of the area.

Inter-War flat buildings are defined as two storeys or more and containing two or more dwellings, constructed in the period circa 1918 to circa 1950.

This definition includes years outside the recognised 'Inter-War period' of 1918 to 1939. This is to recognise a building type and not exclusively buildings constructed between certain years.

This building type is distinguishable by common characteristics and styles. There are many examples of residential flat buildings with these characteristics that were constructed after 1939.

There are numerous cohesive groups and one-off examples that demonstrate the key characteristics of architectural styles of the Inter-War period including Art Deco, Mediterranean, Georgian Revival, Spanish Mission, Skyscraper Gothic and Functionalist. Many of the Inter-War flat buildings across the LGA were designed by prominent architects such as Leslie Wilkinson, Emil Sodersten, Aaron Bolot, Eric Clarke Pitt, John R. Brogan and Samuel Lipson.

Externally, many buildings and their settings are substantially intact. Modern day renovation trends that include rendering or bagging face brick, altering window patterns and enclosing balconies have detrimental impacts on the character of these buildings, particularly their aesthetic values, and also on the general streetscape.

Streetscape

The streetscape is the connection between the private and public domain. The character of the Inter-War flat building streetscapes is their consistency in architectural style, scale, form, front and side setbacks, finishes and materials. In streets characterised by Inter-War residential building development, the subdivision pattern and regular separation of buildings often provides public views to surrounding areas and landmarks.

Landscaped area

The landscaped garden setting is an important element of Inter-War flat buildings and contributes to the character of the building and its setting. The garden setting usually comprises perimeter planting in narrow strips along the front of the buildings and along the side boundary fences framing a small lawn area in front of the buildings.

Building form

The predominant plan form of principal buildings is of a stepped nature with bays, indents, verandahs, balconies and other elements to break up the mass of the building and in particular the street front elevation.

Highly characteristic detailing defines each style within the Inter-War period and contributes to the building's character. Each style can be characterised by the following elements:

- ▶ Art Deco: Face brickwork, vertical and horizontal brick fins, decorative stepped parapets, symmetry, three dimensional massing, geometric curves.

-
- ▶ Mediterranean: Rendered and lime washed walls, round or Marseille tiles, accents of classical detail such as round arches, timber shutter, ornate fine ironwork railings.
 - ▶ Georgian Revival: Symmetry, fine face brickwork, 12 pane windows, repetitive fenestration, semi-circular headed windows, classical columns and pediments.
 - ▶ Spanish Mission: Plain rendered or textured stucco with concentrations of ornament, gabled roofs with curved parapets, half-round terra cotta tiles, triple arch windows, 'barley-sugar' columns.
 - ▶ Skyscraper Gothic: Medieval motifs, tall tower elements, vertical fins, stepped parapets.
 - ▶ Functionalist: Asymmetrical massing of simple geometric shapes, steel-framed windows, contrasting horizontal and vertical motifs, large areas of glass.

Building height

The height of Inter-War flat buildings is generally consistent within the streetscape. The buildings are usually 2 or 3 storeys, but may be up to 10 or 12 storeys.

Materials

Materials characteristic of Inter-War flat buildings are:

- ▶ walls—brick, render/stucco;
- ▶ windows—timber double hung or casement; and
- ▶ roofs—glazed terracotta tile.

Alterations, additions and repairs

Alterations and additions to Inter-War flat buildings should have regard to the existing character of the building and its setting.

Where external elevations and internal common areas are intact, applicants are encouraged to confine alterations to internal areas of individual apartments.

Services and fire upgrades must be carefully planned and detailed. To avoid damage to characteristic internal and external details, repairs to building elements are to retain existing detailing and be equal to the original quality and design of material finishes, fixtures and fittings.

Roofscapes and chimneys

The roof is an important characteristic of Inter-War flat buildings and is generally a hipped or gabled form with a tiled roof structure and decorative parapet features. It contributes strongly to the overall form, proportions and character of the building.

Chimneys are an important characteristic of pre-1950 residential flat buildings and add to the character of the overall building form and area. For example, chimneys may relate to a centralised incinerator system, reflecting a previous technology that is of historic interest.

Dormer windows to the existing roof forms are inappropriate and out of character with Inter-War flat buildings and are intrusive in the roof form. Skylights are intrusive in roof forms and are restricted to areas that are not visibly prominent.

Fences, gates and mailboxes

The front fences of Inter-War flat buildings are usually low scale and constructed of masonry, often incorporating or repeating details used in the building. Gates are generally wrought iron with fine craftsmanship in a design appropriate to the character of the building, and also match external balcony balustrades.

Mailboxes are often timber in a masonry enclosure and located at or near the front fence, or within or near the main entrance to the building.

Ancillary structures

Ancillary structures for Inter-War flat buildings are those buildings that are not the principal building and include, but are not limited to: carports, garages, garbage areas and laundries.

External materials, details and finishes

External materials, details and finishes and the way they in which these are used are important elements that contribute to the overall character of a building. Face brickwork is a key characteristic of Inter-War flat buildings. The use of masonry patterns including two-tone brickwork, squints (corner bricks), textured bricks and herringbone brickwork can contribute to aesthetic value to an Inter-War flat building.

Verandahs and balconies

Existing verandahs and balconies are an important characteristic of Inter-War flat buildings, in addition to being functional and adding visual interest to the exterior by creating shadows. The addition of new balconies can have a highly negative visual impact on the character of the building. Where external elevations are intact and the building displays distinctive characteristic detailing, verandah additions should be limited to building elevations that are not highly visible from the street.

Security devices

In some cases the original door and window hardware does not provide the necessary level of security for contemporary requirements. Additional security devices can be provided sympathetically whilst retaining original hardware and the character of the building.

Fire protection upgrading

To comply with BCA and other requirements, it is sometimes necessary to upgrade the building with additional fire protection equipment or measures. Where characteristic internal and external detailing exists, fire protection upgrading should be sympathetically incorporated to minimise adverse impacts to original fabric and characteristic features of the building, such as doors and fireplaces.

Objectives and controls for alterations and additions to Inter-War flat buildings

Note: The controls below apply in addition to the general residential controls in this chapter. Where there is an inconsistency, the controls below take precedence.

B3.8 Additional controls for development other than dwelling houses	
3.8.7 Inter-War flat buildings	
Objectives	Controls
Streetscape	
O1 To ensure that the significant characteristics of Inter-War flat buildings, in regard to their presentation to the street, are retained and protected.	C1 For Inter-War flat buildings that are heritage items or located in a HCA— No alterations or additions to the significant and/or original forms, details, fabrics, materials or finishes of the principal building elevations, except for restoration or reconstruction.
O2 To conserve the principal street elevations of the Inter-War flat buildings that contribute to the character of the area.	C2 For Inter-War flat buildings that contribute to the character of the area, are not heritage items or located in a HCA— Alterations or additions to the significant forms, details, materials or finishes of the principal building elevations are sympathetic to the style and period of the building, and do not dominate the building.
O3 To ensure that the architectural character of Inter-War flat buildings that contribute to the character of the area is not compromised.	C3 The articulated, stepped and faceted plan form of the building is not altered or obscured, particularly at the street elevation.
O4 To ensure that the character of original roofscapes, including key elements such as chimneys, is maintained.	C4 Alterations and additions are no higher than the existing roof level, and generally retain the original roof form of the building.
O5 To ensure that alterations and additions to the roofs are discrete and do not detract from the original character, proportions or key elements.	C5 The roof maintains traditional roofing materials of the area, such as glazed terracotta tiles. Any replacement or repair matches the original roofing in type, profile, colour and materials. Concrete roofing tiles and corrugated metal roofing are not appropriate.
	C6 Dormer windows or skylights are not visually prominent from the public domain

B3.8 Additional controls for development other than dwelling houses

3.8.7 Inter-War flat buildings

Objectives	Controls
	<p>or the principal elevations of the building.</p> <p>C7 Skylights are flush with the roof surface.</p> <p>C8 Original chimneys and their details are retained.</p>
<p>O6 To conserve the established garden settings, including significant elements and features.</p>	<p>C9 Characteristic front gardens, and their elements, are retained with minimal alteration.</p> <p>C10 Structures are not erected in the front garden that detract from the feeling of openness, or restrict or impact on the principal elevations of the building (including secondary fences and hedges).</p> <p>C11 Structures erected in the front garden do not significantly reduce or compromise the landscaped area or key elements and features.</p>
<p>O7 To ensure that parking does not detract from the character of the streetscape.</p>	<p>C12 Car parking and garage structures are located at the rear, with access from the rear lane or side driveway.</p>
<p>O8 To ensure that external alterations, additions and repairs do not detract from the original character and form of the building.</p>	<p>C13 External alterations and additions do not impact on the overall form and character of the building, and are not visually prominent from the public domain.</p> <p>C14 External windows and doors are repaired or replaced to match the style, materials and finishes of the original building.</p> <p>C15 Privacy screens are discreet and do not impact on the overall character of the building, and are visible from the street.</p> <p>C16 Shade structures, including awnings and canopies, are not located on the principal building elevations.</p> <p>C17 Alterations to improve accessibility (including lifts, ramps and stairs) are sympathetically integrated with the original building and retain the original</p>

B3.8 Additional controls for development other than dwelling houses

3.8.7 Inter-War flat buildings

Objectives	Controls
	<p>character and design of the building and landscape areas.</p>
<p>O9 To ensure that external materials, details and finishes respect and complement the original building.</p>	<p>C18 Materials are similar in type and finish to those on the original building and sympathetically integrate with the fabric of the building.</p> <p>C19 Individual materials do not dominate the original materials of the building.</p> <p>C20 Original face brickwork is not painted, rendered or coated.</p> <p>C21 Windows are timber double hung or casement with the glazing pane size to be conserved and match the original windows.</p> <p>C22 Original leadlight, glass blocks, etched and patterned glazing are retained and conserved.</p>
<p>O10 To ensure that works to balconies and verandahs do not detract from the character and form of Inter-War flat buildings.</p>	<p>C23 Original verandas and balconies to the principal elevation of the building are not enclosed, glazed, or otherwise altered, except to reinstate original detailing.</p> <p>C24 New verandahs and balconies:</p> <ul style="list-style-type: none"> a) respect the character of the existing building; and b) are sympathetically integrated with the character and form of the building.
<p>O11 To ensure that fences, gates and mailboxes are consistent with the character of Inter-War flat buildings.</p>	<p>C25 Original fencing, gates and mailboxes are retained and conserved.</p> <p>C26 Fences to the front building alignment are a height of between 400mm and 900mm. The height, style, form, materials and finishes match the principal building and the streetscape.</p> <p>C27 Gates are constructed in a height, style,</p>

B3.8 Additional controls for development other than dwelling houses

3.8.7 Inter-War flat buildings

Objectives	Controls
	<p>form, materials and finishes to match the principal building and streetscape. Aluminium gates are avoided.</p> <p>C28 Fencing to side and rear boundaries is in the form of a timber paling fence.</p> <p>C29 Mailboxes are constructed in style, form, materials and finishes to match the principal building and streetscape.</p> <p>C30 Mailboxes are discreetly located and do not impact on the character of the building.</p>
<p>O12 To ensure that internal additions, alterations and repairs retain and respect internal common areas and significant internal character elements.</p>	<p>C31 Internal common areas and significant character elements are retained. This includes: entry doors, foyer areas and fittings, mailboxes, noticeboards, staircases, balustrades, carpets, wall details, light fittings, internal doors and the like.</p>
<p>O13 To ensure that the installation and maintenance of security devices does not detract from the character and form of Inter-War flat buildings.</p>	<p>C32 Original door and window hardware is retained, where practical. New additional security elements are in character with the building.</p> <p>C33 Security bars are:</p> <ul style="list-style-type: none"> a) fitted internally; b) respect the existing glazing patterns; and c) painted in a dark recessive colour. <p>C34 Security intercom systems are discreetly located and in a style and materials complimentary to the character of the building.</p> <p>C35 Alarm bell boxes and the like, are not attached to the principal building elevations.</p>
<p>O14 To ensure that additions and alterations</p>	<p>C36 New or upgraded services are discreetly</p>

B3.8 Additional controls for development other than dwelling houses

3.8.7 Inter-War flat buildings

Objectives	Controls
<p>for fire upgrading and safety are discrete, and retain and respect the original and significant building fabric.</p>	<p>and sensitively located to minimise visual impact.</p> <p>C37 New or upgraded services, such as rising mains and wiring, are located within existing ducts, behind cornices or bulkheads or within external lightwells that are not visually prominent.</p> <p>C38 Wiring or other services are housed in concealed conduits.</p> <p>C39 Original timber staircases are retained and smoke isolated, if necessary.</p> <p>C40 Where the height of the original stair balustrades is modified for fire safety—the modification is discreet and sympathetically integrated with the existing stair balustrade.</p> <p>C41 Stair treads applied to existing stairs are discrete.</p> <p>C42 New lifts are designed and located so that the addition:</p> <ul style="list-style-type: none"> a) is located outside the principal building form, if practical; and b) does not require significant alterations to existing common areas. <p>C43 Existing original external and internal doors and door hardware are retained and upgraded rather than replaced.</p> <p>C44 Existing original fanlights and other openings are retained and sealed from behind, if necessary.</p> <p>C45 Emergency and exit lighting is incorporated into existing original light fittings, where practical.</p> <p>C46 Smoke and/or thermal detectors are discreetly located and do not impact on decorative plaster cornices and ceilings.</p>

B3.8 Additional controls for development other than dwelling houses

3.8.7 Inter-War flat buildings

Objectives	Controls
<p>O15 To ensure that ancillary development does not detract from the style and character of Inter-War flat buildings and their settings.</p>	<p>C47 Ancillary development, such as garages and laundries, constructed at the same time as the building are retained. Any modifications are sympathetic to the original building.</p> <p>C48 New ancillary development:</p> <ul style="list-style-type: none"> a) is smaller in scale than the principal building; b) is not located between the principal building and the street front, and generally located at the rear behind the principal building; c) is constructed in a style, form, materials and finishes that match the principal building; d) is single storey with a maximum clear internal height of 2.4m; and e) is sympathetic in scale and style to traditional forms of ancillary structures.
<p>O16 To promote restoration and reconstruction works to restore significance.</p>	<p>C49 Unsympathetic additions and modifications to the building, and its grounds, are removed and replaced with sympathetic works, or reinstatement of original forms and matching fabric.</p>

B3.8.8 Post-1950s residential towers

The post-1950s residential towers are generally between 10 and 25 storeys high, and set on large sites with significant setbacks providing a garden setting to the street. These towers generally occur on the ridges of Darling Point and Point Piper and are visually prominent, particularly from Sydney Harbour.

B3.8 Additional controls for development other than dwelling houses

▶ 3.8.8 Post-1950s residential towers

Objectives	Controls
<p>O1 To ensure that additions and alterations do not have an unsympathetic impact on the architectural style of the original building.</p>	<p>C1 Alterations and additions to post-1950s residential towers have regard to:</p>
<p>O2 To ensure that additions and alterations do not detract from the character of the area or have an unreasonable impact on surrounding properties.</p>	<ul style="list-style-type: none"> a) their visual prominence; b) impacts on views from public spaces; c) impacts on view sharing from private properties; d) the architectural integrity of the existing building; and e) the materials and finishes of the existing building.

B3.8.9 Non-residential development

A number of non-residential land uses, such as child care centres, community facilities, educational establishments and places of public worship are permitted within the residential zones.

Where a non-residential use is proposed, the development must be compatible with the desired future character of the area in terms of building scale, location and design, and the impacts arising from the use must not unreasonably compromise residential amenity.

Notes:

- ▶ On-site parking rates and design requirements are in Part E of the DCP, Chapter E1 Parking and Access.
- ▶ Additional controls are in Part F of the DCP, Chapters F1 Child Care Centres and Chapter F2 Educational Establishments.

B3.8 Additional controls for development other than dwelling houses

▶ 3.8.9 Non-residential development

Objectives	Controls
<p>O1 To ensure that non- residential development is consistent with the desired future character of the area and does not have an unreasonable impact on surrounding properties</p>	<p>C1 The built form complies with the building envelope, footprint, excavation and built form and context controls in Sections B3.2-B3.4.</p> <p>Note: The minimum side setback for non-residential development is determined by the table in Figure 6 and is measured at 90 degrees to the side boundary (refer Figure 4).</p> <p>C2 The development is compatible with the streetscape and the desired future character of the street. For example, buildings in residential areas must maintain a scale consistent with the streetscape.</p> <p>Note: Chapters B1 and B2 in this Part of the DCP define the desired future character for each precinct, and identify any special heritage, streetscape character and key elements within each precinct.</p> <p>C3 Lighting, noise, hours of operation, and intensity of the use do not unreasonably impact on the residential amenity of adjoining properties, the street, or</p>

B3.8 Additional controls for development other than dwelling houses

3.8.9 Non-residential development

Objectives	Controls
	precinct.
	<p>C4 A management plan may be required to be submitted with the DA identifying the proposed uses on the site, and how the impacts of those uses will be managed and minimised. Matters that may need to be addressed in the management plan include:</p> <ul style="list-style-type: none"> a) pedestrian and vehicular access; b) parking and servicing; c) capacity; d) hours of operation; e) lighting; f) noise; and g) security and safety. <p>C5 For any non-residential development (including attached and detached garaging) the maximum volume of excavation permitted is no greater than the volume shown in Figure 14.</p>

B3.9 Additional controls for development on a battle-axe lot

A battle-axe lot is a lot that is connected to a road by an access handle. It does not have a street frontage, and directly adjoins other properties at all boundaries.

The controls below recognise that development on battle-axe lots needs to particularly consider the amenity of both the occupants and the adjoining properties, having regard to privacy, solar access, open space and the like.

Note, under Woollahra LEP 2014 the maximum height for development on a battle-axe lot is 9.5m.

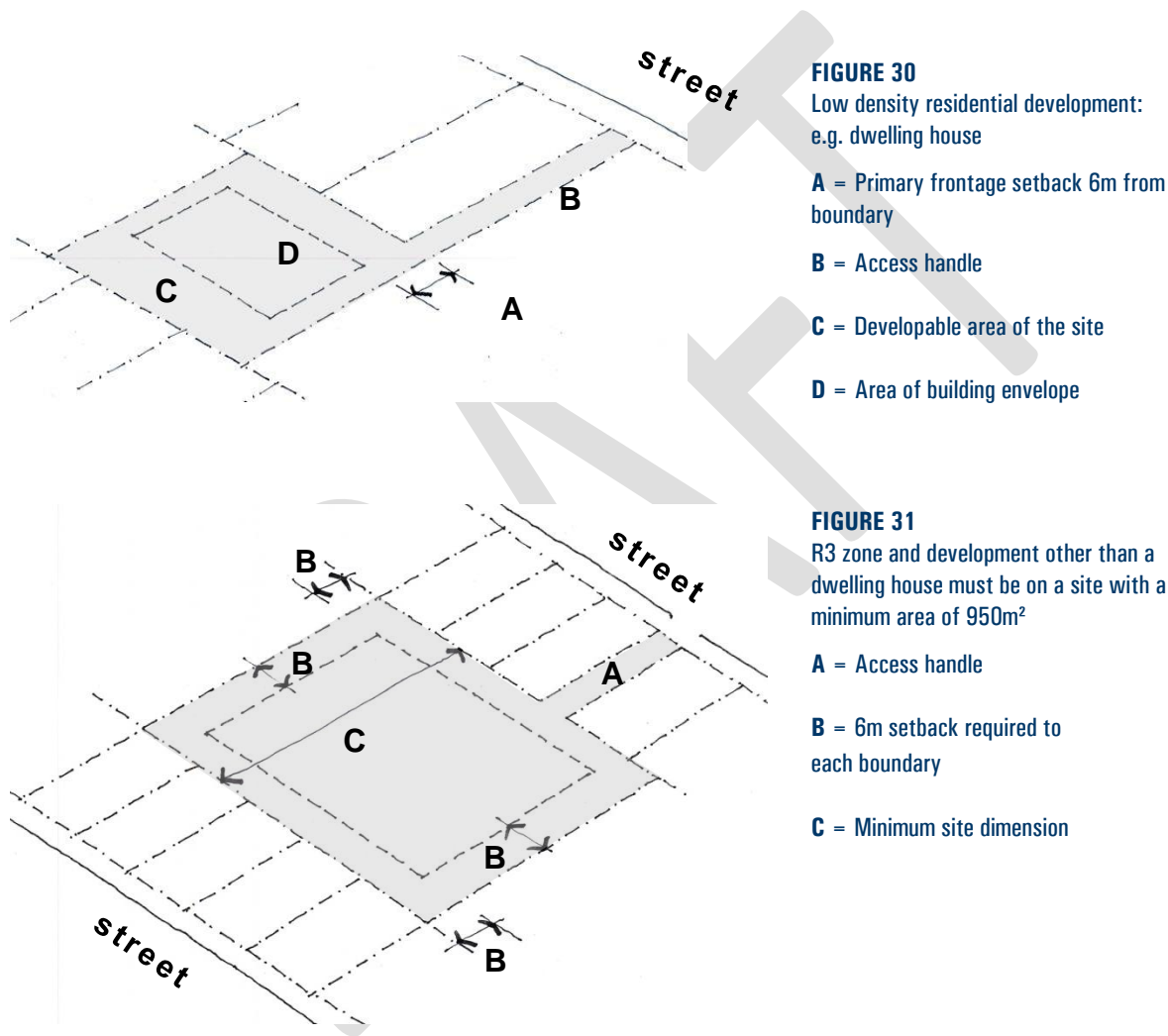

B3.9 Additional controls for development on a battle-axe lot	
Objectives	Controls
<p>O1 To ensure that the battle-axe lot is of a size that can provide for the amenity of occupants and adjoining properties.</p>	<p>C1 For development other than a dwelling house in the R3 Medium Density Residential Zone—the minimum lot size is 950m².</p> <p>C2 The lot, excluding the access handle, has minimum dimension in any direction, as follows:</p> <ul style="list-style-type: none"> a) for a detached dual occupancy—21m b) for development involving three or more dwellings—24m. <p>Note: The access handle of a battle-axe lot is included in calculating the lot size.</p>
<p>O2 To ensure adequate building separation to provide for the amenity of occupants and adjoining properties.</p>	<p>C3 For development in the R2 Low Density Residential Zone—a 6m setback applies to the primary frontage (refer to Figure 30).</p> <p>Note:</p> <ul style="list-style-type: none"> a) the primary frontage is the boundary closest to the access handle leading to the street; and b) side and rear setbacks in Sections 3.2.3 and 3.2.4 apply. <p>C4 For development in the R3 Medium Density Residential Zone, a 6m setback applies to all boundaries (refer to Figure 31).</p> <p>A reduced setback may be considered where there is no unreasonable impact on the amenity of adjoining properties having regard to privacy, solar access, sense of enclosure and view sharing.</p> <p>Note: A 7.2m wall height applies (refer to Sections 3.2.5).</p> <p>C5 Notwithstanding C3, a setback of 12m applies to:</p> <ul style="list-style-type: none"> a) land at 327, 327C, 327D, 337, and 337A, Edgecliff Road (being Lot 4 DP 320118, Lot 1 DP 566991, Lot X DP 101456, Lot C DP 323192, and Lot 12 DP 851270,) and 14, 20, and 22 Roslyndale

B3.9 Additional controls for development on a battle-axe lot	
Objectives	Controls
	<p>Avenue (being Lot 101 DP 738428, Lot 6 DP 9477 and Lot 7 DP 9477) along the eastern most boundary that directly adjoins R2 zoned land; and</p> <p>b) land at 345 Edgecliff Road (Lot E DP 331031) along the southern most boundary that directly adjoins R2 zoned land.</p> <p>Note: The 6m setback applies to all other boundaries.</p>
<p>O3 To ensure that development does not unreasonably affect adjoining properties in terms of privacy and sense of enclosure.</p>	<p>C6 Primary living areas, such as a living room, lounge room, kitchen and dining room, are located on the ground floor. Habitable rooms other than bedrooms, on the upper floors will only be considered where there is:</p> <p>a) no unreasonable impact on the privacy of adjoining properties; and</p> <p>b) no overlooking into the private open space areas of adjoining properties.</p> <p>C7 In the R2 zone, where habitable rooms other than bedrooms are located on the upper floor, the windows to these rooms are setback at least 4.5m from any boundary.</p> <p>C8 Balconies, decks and the like, on the upper floors will only be considered where there is:</p> <p>a) no unreasonable impact on the privacy of adjoining properties; and</p> <p>b) no overlooking into the private open space areas of adjoining properties.</p>

B3.10 Additional controls for development in sensitive locations

B3.10.1 Development on land adjoining public open space

This section applies to land that directly adjoins land zoned RE1 Public Recreation, E1 National Parks and Nature Reserves, and E2 Environmental Conservation.

Parks, reserves and other public open space areas contribute significantly to the amenity and well-being of the community.

Many of these areas are close to the harbour foreshore and provide an important contribution to scenic quality. Some of these parks and reserves contain remnant vegetation and ecological communities worthy of protection.

Development, including landscaping, on private property adjoining public open space areas needs to consider its relationship to the public land and be sensitively managed to minimise potential impacts on the amenity of these public open space areas.

B3.10 Additional controls for development in sensitive locations

► 3.10.1 Development on land adjoining public open space

Objectives	Controls
<p>O1 To ensure that development on land adjoining public open space areas does not compromise the public use or amenity of the land.</p>	<p>C1 Development does not conflict with any plan of management applying to public land.</p>
	<p>C2 Development does not have an unreasonable impact on the public open space area in terms of:</p> <ul style="list-style-type: none"> a) overshadowing; b) scale or sense of enclosure; and c) loss of significant views.
	<p>C3 Fencing and landscaping along any common boundary makes a positive contribution to the public open space area.</p>
<p>O2 To improve opportunities for passive surveillance into public open space areas.</p>	<p>C4 Where practical, the building is designed to have an outlook to the adjoining public open space area.</p>

B3.10 Additional controls for development in sensitive locations

3.10.1 Development on land adjoining public open space

Objectives		Controls	
O3	To protect and enhance public access to public open spaces.	C5	Development does not reduce existing public access to public open space areas. When possible, development increases opportunities for public access.
O4	To ensure that development does not have an adverse impact on the ecology of adjoining parks, reserves or other public open space areas.	C6	A gate or the like, providing direct access from a private property to the public park or reserve opens inward toward the private property and does not encroach on public land.
O5	To ensure that development adjoining open space provides for a continuation and support of native vegetation and habitat areas.	C7	For new plantings, 90% of the plants in the landscape design are native species. However, where the land adjoins bushland to which <i>State Environmental Planning Policy No 19—Bushland in Urban Areas</i> applies, 100% of the plants are locally occurring native species.
O6	To ensure that development does not impact on the environmental processes of the public land, such as soil erosion, siltation, and the like.	C8	Landscaping provides a diversity of native species and a complexity of habitat through vertical layering. Note: Refer to the DA Guide for suggested vegetation species.

B3.10.2 Harbour foreshore development

Sydney Harbour is an outstanding natural and public asset of national significance with unique environmental qualities that are world renowned. Woollahra Council has a shared responsibility with the State government and other councils with harbour foreshore land to ensure its protection for existing and future generations.

In 2005 the State Government introduced the *Sydney Regional Environmental Plan (Sydney Harbour Catchment) 2005* (Harbour REP) to provide clear planning framework and better environmental outcomes for Sydney Harbour. The Harbour REP applies not only to the waterways and foreshores of the harbour, but to the wider hydrological catchment.

The provisions in this part of the DCP supplement the Harbour SREP, and particularly address scenic and environmental protection issues. These DCP provisions apply to:

- ▶ land that has a boundary to the Sydney Harbour foreshore;
- ▶ land adjoining the Sydney Harbour foreshore which is zoned E1 National Parks and Nature Reserves or RE1 Public Recreation; and
- ▶ any land visible from Sydney Harbour.

Scenic protection

The appearance of development when viewed from Sydney Harbour is an important consideration for development.

Scenic protection is not just relevant to land immediately adjacent to the foreshore, but applies to development on any land that is visible from Sydney Harbour. This is because building form, scale, materials and vegetation cover of development located along the slopes and ridgelines visible from the harbour are also important in contributing to, and protecting, the harbour's scenic qualities.

Ecological communities and protection of the natural foreshore

The harbour foreshore supports a vast array of flora and fauna communities. It is important to minimise the impact of development to preserve natural ecosystems and protect the natural foreshore character.

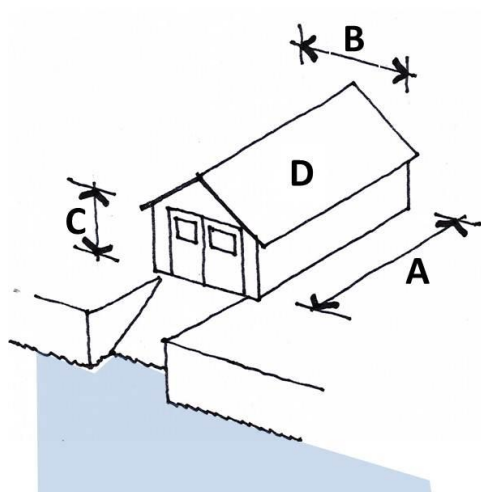

FIGURE 32
Design considerations for boat sheds

- A** = Maximum length 5m
- B** = Maximum width 3.7m
- C** = Maximum wall height 2.5m
- D** = Minimum roof pitch 30°

B3.10 Additional controls for development in sensitive locations

▶ 3.10.2 Harbour foreshore development

Objectives	Controls
<p>O1 To protect the scenic quality of the natural landscape and built environment, particularly as viewed from Sydney Harbour.</p>	<p>C1 Development as viewed from Sydney Harbour follows the natural topography and maintains or enhances vegetation cover.</p> <p>C2 Roofs are below the tree canopy and maintain the prominence of the treed skyline.</p> <p>C3 Development as viewed from Sydney Harbour, is designed and constructed to blend with the natural landscape setting and the existing built environment through the use of materials, colours, wall articulation, building form and landscaping. Glass elevations and excessive use of windows resulting in reflectivity and glare are avoided.</p> <p>C4 Pergolas, boatsheds, other outbuildings and structures are designed and constructed to complement the overall appearance of the development. Such structures are no more than one storey in height.</p> <p>C5 Swimming pools and spa pools are not elevated more than 1.2m above ground level and complement the character of the harbour and foreshore.</p> <p>C6 Swimming pool and spa pool walls are suitably</p>

B3.10 Additional controls for development in sensitive locations

3.10.2 Harbour foreshore development

Objectives	Controls
	<p>treated to complement the natural foreshore, and where visible, are sandstone clad and incorporate suitable screen landscaping.</p>
	<p>C7 The boatshed is designed to directly relate to the water, with openings and access facing the water.</p>
	<p>C8 Boatsheds are used solely for the storage and/or maintenance of boats.</p>
	<p>C9 Boatsheds have maximum plan dimension of 6m x 3.7m. Boatsheds are sited so that the minimum dimension fronts the harbour (refer to Figure 32).</p>
	<p>C10 Boatsheds incorporate gable pitched roofs with a minimum pitch of 30°. The use of roofs as sundecks, patios or the like is not permitted (refer to Figure 32).</p>
	<p>C11 Boatsheds are single storey and have a maximum wall height of 2.5m (refer to Figure 32).</p>
	<p>C12 Boatsheds are constructed of stone or timber. Excessive use of glazing is avoided.</p>
	<p>C13 Jetties are constructed of hardwood, are of minimum size and are designed to be as unobtrusive as possible. The sharing of jetties between properties is encouraged and, where possible, jetties are constructed on common boundaries to limit the proliferation of structures along the foreshore.</p>

B3.10 Additional controls for development in sensitive locations

3.10.2 Harbour foreshore development

Objectives	Controls
<p>O2 To minimise impacts on natural coastal processes, including sea level rises and flooding.</p>	<p>C14 Boundary fences are not permitted within 8m of the mean high water mark.</p> <p>C15 Within the foreshore area:</p> <ul style="list-style-type: none"> a) fences are not more than 1.5m in height above the existing ground level, and are constructed of open weave materials (such as wire or lattice to enable vines, creepers or hedges) to provide natural cover; b) boundary planting is not higher than 1.5m when fully mature; and c) hard surfaces and artificial surfaces, such as paving, are minimised and generally limited to swimming pool surrounds or modest walkways between the residential building and foreshore structures, such as swimming pools or boat ramps. <p>Note: Foreshore area means the land in foreshore area 12 and 30 in Woollahra LEP 2014.</p>
<p>O3 To protect natural habitats and minimise disturbance on ecological communities.</p>	<p>C16 Development on foreshore properties maintains or reduces current levels of site stormwater or sediment run-off entering the harbour.</p> <p>C17 Development is not located within seagrass communities and avoids shading of seagrass communities.</p> <p>C18 Development and construction does not disturb seabed contaminants.</p> <p>C19 The existing tree canopy is maintained or enhanced.</p>

B3.10 Additional controls for development in sensitive locations

3.10.2 Harbour foreshore development

Objectives	Controls
<p>O4 To reinforce the natural character of the foreshore and limit disturbance to the natural land and water interface.</p>	<p>C20 Development on foreshore properties does not significantly alter the topography and preserves natural foreshore features including cliffs, rock outcrops, rock shelves and beaches.</p> <p>C21 Seawalls or retaining walls are not permitted in areas where the foreshore is in its natural state.</p> <p>C22 Where seawalls or retaining walls are permitted, these are:</p> <ul style="list-style-type: none"> a) constructed of coarse, rock-faced stone or with stone facing (preferably sandstone); b) no more than 1m above the mean high water mark; and c) be designed and built to improve the environmental value of seawalls and seawall-lined foreshores (refer to <i>Environmentally Friendly Seawalls: A Guide to Improving the Environmental Value of Seawalls and Seawall-lined Foreshores in Estuaries</i>, published by the Department of Environment and Climate Change NSW on behalf of Sydney Metropolitan Catchment Management Authority). <p>C23 Slipways and stairs are designed and constructed to closely conform to the character of the natural foreshore.</p>